

Lights-Architectural Catalogue 2024

SAMPLE 28

BUILD YOUR DREAMS WITH RELIABLE SOURCING FROM CHINA

for

19+ YEARS



+ (86) 186-8880-7020

Reflection shade bracket series with grid

HMS-1002

Features:

- Lamp has unique grid shape ,safe and protective design,,pleasing to the eye and elegant,and reflection ratio of 85%.
- Lamp body is made with 0.6mm high-quality high-strength steel sheet and undergoes rust removal,grease removal,and rustproof treatment,and full spray-coated treatment,no rust will appear for normal indoor use for above 8 years.
- Reflector shade:Uses paracurve arc design and made with imported German or American anodized mirror-or matt-surface aluminum,and no photochromic change for over 8 years under normal ues.
- Uses HEME electronic ballast with high efficiency,energy saving and long service life.

AL-1 1



Standard inductive ballast series

HMK26W/18W/13W

Features:

+ (86) 186-8880-7020

- Uses high-quality silicon steel sheet, low temperature rise, and small power consumption.
- Uses high-quality enameled wire, good heat resistance, maximum working temperature of 120°C allowed, and stable performance.
- Uses vacuum dip-painting technique, super noiselessness, and long service life for 10 years.

Model specification list :

Model	Spec	Working Voltage	COS Input	Current(A)	Dimension (mm) (A×B×H)
Energy-saving inductive ballast					
HMK-26W	26W	220/50Hz	0.50	0.315	105×40×28
HMK-18W	18W	220/50Hz	0.50	0.22	90×40×28
HMK-13W	13W	220/50Hz	0.45	0.165	90×40×28
HMK-10W	10W	220/50Hz	0.35	0.19	90×40×28



Ceiling seagull-type lamp panel series

+86 186 8880-7020

Features:

- No-glare design,using secondary-reflection theory,bright lighting but no glare
- Lamp body is made with 0.6mm high-quality high-strength steel sheet and undergoes rust removal,grease removal,and rustproof treatment,and full spray-coated treatment,no rust will appear for normal indoor use for above 8 years.
- Reflector:uning pure aluminum mesh,paracurve indirect reflection design,and avoid the glare.
- Uses HEME inductive ballast or electronic ballast with efficiency,energy saving and long service life.

Model specification list:

Model	Spec	Long (mm)	Wide (mm)	High (mm)	Packing Size (cm)	Quantities (pcs/ctn)
HML-0343	2×20W	639	460	130	70×25×19	1
	2×14W	598	460	130	67×25×19	1



Built-in T5 I-model grid lamp panel series with net HMT-0512

Features:

- T5 tube lamp is an internationally popular new type energy-saving lamp with the feature of high efficiency, energy saving, low power expenditure, and long service life, and saves above 30% of electric power than T8 luminous tube.
- The bottom plate uses new sloping bottom design, has a height of 55mm and extra-thin design, and could be used with ceiling keel of different types and structures.
- Lamp body is made with 0.6mm high-quality high-strength steel sheet and undergoes rust removal, grease removal, and rustproof treatment, and full spray-coated treatment, no rust will appear for normal indoor use for above 8 years.
- Reflector: web-plate paracurve reflector design, glare proof, wide illumination, made with imported German or American anodized mirror- or matt-surface aluminum, and no photochromic change for over 8 years under normal use.
- Uses HEME electronic ballast with high efficiency, energy saving and long service life.

Model specification list:

Model	Spec	Long (mm)	Wide (mm)	High (mm)	Cut-out A×B (mm)	Packing Size (cm)	Quantities (pcs/ctn)
HMT-0512	2×28W	1198	298	55	1180×280	123×32×14	2

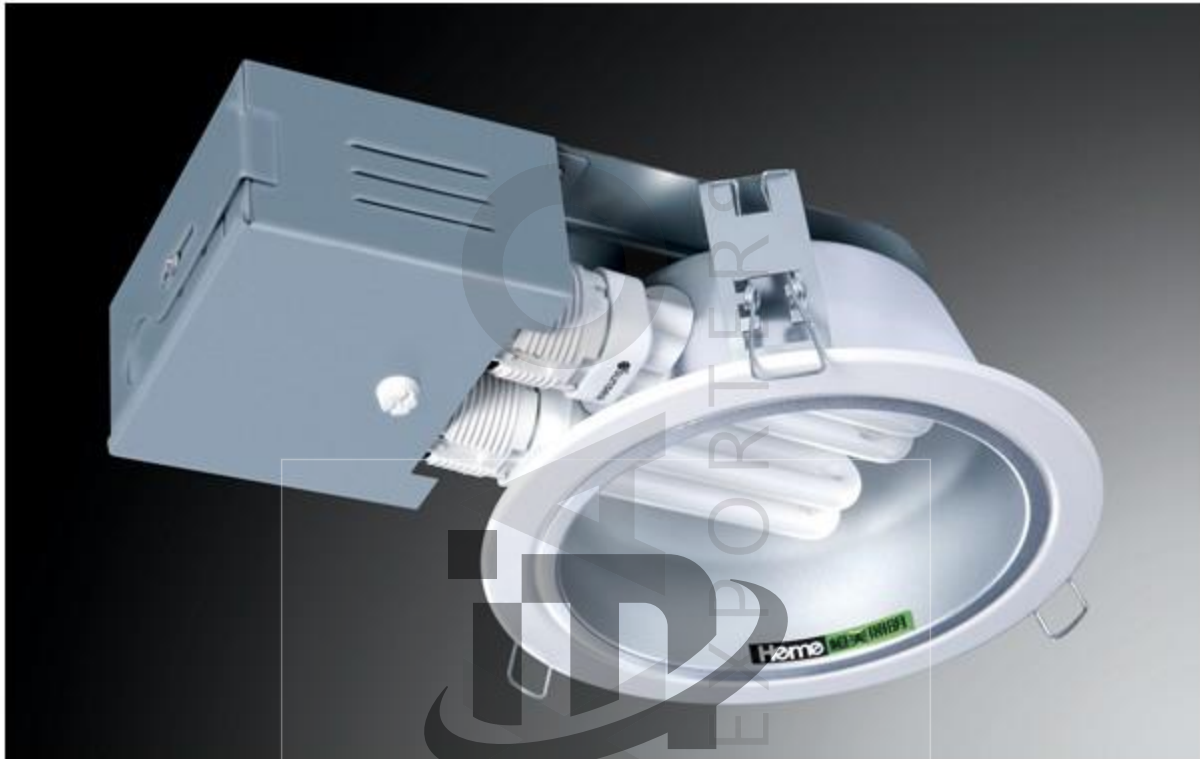

Ordinary transverse plug-in accent lamp series

+ (86) 186-8880-7020
HMC-363A

Features:

- Lamp body uses high-quality 1mm electrolysis plate,the cast practical,and easy for mounting .
- Reflector:made with imported high-purity 1mm aluminum with Taiwan techniques,anodized treatment,and no photochromic change for over 8 years under normal indoor use.
- Uses HEME electronic ballast with high efficiency,energy saving and long service life.

Model specification list:

Model	Spec	Exterior Size (mm)	High (mm)	Cut-out Φ (mm)	Packing Size (cm)	Quantitis (pcs/ctn)
HMC-363A	6 inch 2x18W	195	100	170	65x44x38	12



Euro 068 grid lamp panel series

HMB-0681

+ (86) 186-8880-7020

Features:

- The bottom plate uses new sloping bottom design, and could be used with ceiling keel of different types and structures.
- Lamp body is made with 0.6mm high-quality high-strength steel sheet and undergoes rust removal, grease removal, and rustproof treatment, and full spray-coated treatment, no rust will appear for normal indoor use for above 8 years.
- Reflector: para curve reflector design, full-range reflection, made with imported German or American anodized mirror- or matt-surface aluminum, and no photochromic change for over 8 years under normal indoor use.
- Uses HEME inductive ballast or electronic ballast with efficiency, energy saving and long service life.

Model specification list:

Model	Spec	Long A (mm)	Wide B (mm)	High H (mm)	Cut-out A×B (mm)	Packing Size (cm)	Quantities (pcs/ctn)
HMB-0681	3×40W	1198	598	85	1180×580	126×63×19	2



Built-in T5 V-model grid lamp panel series with net HMT-0522

Features:

- T5 tuing lamp is an interationally popular new type energy-saving lamp with the feature of high efficiency,energy saving,low power expenditure,and long service life,and saves above 30% of electric powe than T8 luminous tube.
- The bottom plate uses new sloping bottom design,has a height of 55mm and extra-thin design,and clould be used with ceiling keel of different types and structures.
- Lamp body is made with 0.6mm high-quality high-strength steel sheet and undergoes rust removal,grease removal,and rustproof treatent,and full spray-coated treatent,no rust will appear for normal indoor use for above 8 years.
- Refector:web-plate paracurve reflector design,glare proof,wide illumination,made with imported German or American anodized mirror-or matt-surface aluminum,and no photochromic change for over 8 years under normal ues.
- Uses HEME electronic ballast with high efficiency,energy saving and long service life.

Model specification list:

Model	Spec	Long (mm)	Wide (mm)	High (mm)	Cut-out A×B (mm)	Packing Size (cm)	Ouantities (pcs/ctn)
HMT-0522	2×28W	1198	298	55	1180×280	123×32×14	2



Euro cleansing cast aluminum vertical plug-in accent lamp series

HMC-169B

+ (86) 186-8880-7020

Features:

- The lamp uses appearance and practicality patent,dual-ring surface die-cast aluminum surface design,pleasing to the eye and practical,and easy for mounting.
- Lamp body uses high-purity aluminum by die casting and imported 1mm electrolysis plate,the cast aluminum never rusting;and the electrolysis plate is pleasing to the eye and durable,and not liable to rusting.
- Reflector:made with imported high-purity 1mm aluminum with Taiwan techniques,anodized treatment,and no photochromic change for over 8 years under normal indoor use.
- Equipped with safety toughened glass shade ,so the reflector could keep high high lighting output for a long run and play a cleaning role.
- Uses HEME inductive ballast or electronic ballast with efficiency,energy saving and long service life.

Model specification list:

Model	Spec	Exterior Size (mm)	High (mm)	Cut-out Φ (mm)	Packing Size (cm)	Quantitis (pcs/ctn)
HMC-169B	6 inch 1×E27	200	190	185	65×44×44	12



Euro diffuse reflection film model space lamp panel series with frame

+ (86) 186 8880-7020
HMLT5832

Features:

- Using appearance and practicality patent, secondary reflection design, and has illumination strength 20% more than ordinary lamp.
- Lamp body is made with 0.6mm high-quality high-strength steel sheet and undergoes rust removal, grease removal, and rustproof treatment, and full spray-coated treatment, no rust will appear for normal indoor use for above 8 years.
- Light-passing board uses imported ivory-white board, ultraviolet-resistance treatment, dustproof, easy for cleaning, no glare, no color change under long-term sunshine, and light ratio reaching 85%.
- Uses HEME inductive ballast or electronic ballast with efficiency, energy saving and long service life.

Model specification list:

Model	Spec	Long (mm)	Wide (mm)	High (mm)	Cut-out A×B (mm)	Packing Size (cm)	Quantities (pcs/ctn)
HML-T5832	2×28W	1198	598	110	1180×580	126×63×24	2



Built-in grid spot lamp series

+ (86) 135 8830-7020

Features:

- The lamp uses dual-ring adjustable-angle design, wide illumination angle, wide application, pleasing to the eye and practical, and easy for mounting.
- Lamp bracket is made with high-purity aluminum alloy by die casting, undergoes treatment of grease removal and metallic paint spray-coated, and never rusting; the lamp bottom is made with 0.5mm high-strength steel sheet, undergoes rust removal, and dustproof treatment, and spray-coated in black color..
- Uses HEME electronic ballast with high efficiency, energy saving and long service life.

Model specification list:

Model	Spec	Exterior Size A (mm)	High H (mm)	Cut-out Φ (mm)	Packing Size (cm)	Quantities (pcs/ctn)
HMX-002	2×50W	390×205	130	370×180	81×46×35	8



Aluminum alloy wire-casing band bracket series HMS-0180(3.66m)

Features:

- The lamp uses streamline paracurve arc design which could be connected to unlimited length,wide illumination area,pleasing to the eys and durable,and reflection-ratio of 85%.
- Lamp body and shade are made by compression moulding of high-purity aluminum alloy,anodized treatment or full spray-coated treatment,and never rusting.
- Uses HEME electronic ballast with high efficiency,energy saving and long service life.

Model specification list:

Model	Spec	Long (mm)	Wide (mm)	High (mm)	Packing Size (cm)	Quantities (pcs/ctn)
HMS-0180	2×40W	3660	180	100	372×24×13	6



Built-in T8 V-model grid lamp panel series with net

HMB-0912

+ (86) 186-8880-7020

Features:

- The bottom plate uses new sloping bottom design, and could be used with ceiling keel of different types and structures.
- Lamp body is made with 0.6mm high-quality high-strength steel sheet and undergoes rust removal, grease removal, and rustproof treatment, and full spray-coated treatment, no rust will appear for normal indoor use for above 8 years.
- Reflector: para curve reflector design, full-range reflection, made with imported German or American anodized mirror- or matt-surface aluminum, and no photochromic change for over 8 years under normal indoor use.
- Uses HEME inductive ballast or electronic ballast with efficiency, energy saving and long service life.

Model specification list:

Model	Spec	Long (mm)	Wide (mm)	High (mm)	Cut-out A×B (mm)	Packing Size (cm)	Quantities (pcs/ctn)
HMB-0912	2×40W	1198	298	85	1180×280	126×32×19	2



Euro cleansing PC transverse plug-in accent lamp series HMC-281A

Features:

- The lamp uses appearance and practicality patent, PC flame retardant plastic surface design, pleasing to the eye and practical, and easy for mounting.
- Lamp body uses high-quality 1mm electrolysis plate, the cast practical, and easy for mounting.
- Reflector: made with imported high-purity 1mm aluminum with Taiwan techniques, anodized treatment, and no photochromic change for over 8 years under normal indoor use.
- Equipped with safety toughened glass shade, so the reflector could keep high light output for a long run and play a cleaning role.
- Uses HEME inductive ballast or electronic ballast with efficiency, energy saving and long service life.

Model specification list:

Model	Spec	Exterior Size (mm)	High (mm)	Cut-out Φ (mm)	Packing Size (cm)	Quantities (pcs/ctn)
HMC-281A	8 inch 2×26W	240	130	225	60×38×54	8
	8 inch 2×18W	240	130	225	60×38×54	8



Euro cleansing PC vertical plug-in accent lamp series

HMC-267A

Features:

+ (86) 186-8880-7020

- The lamp uses appearance and practicality patent, PC flame retardant plastic surface design, pleasing to the eye and practical, and easy for mounting.
- Lamp body uses high-quality 1mm electrolysis plate, the cast practical, and easy for mounting.
- Reflector: made with imported high-purity 1mm aluminum with Taiwan techniques, anodized treatment, and no photochromic change for over 8 years under normal indoor use.
- Equipped with safety toughened glass shade, so the reflector could keep high light lighting output for a long run and play a cleaning role.
- Uses HEME inductive ballast or electronic ballast with efficiency, energy saving and long service life.

Model specification list:

Model	Spec	Exterior Size (mm)	High (mm)	Cut-out Φ (mm)	Packing Size (cm)	Quantities (pcs/ctn)
HMC-267A	6 inch 1x18W	200	190	185	65x44x44	12



Ceiling cleansing ivory-white organic sheet lamp panel series

HMA-0431
 +(86) 186-8880-7020

Features:

- Uses special design, special rubber installed in-between lamp and transparent shade to acquire sealing effect, buckle spring design, and easy mounting and maintenance.
- Lamp body is made with 0.6mm high-quality high-strength steel sheet and undergoes rust removal, grease removal, and rustproof treatment, and full spray-coated treatment, no rust will appear for normal indoor use for above 8 years.
- Protecting shade: uses imported ivory-white sheet; light ratio of 75%, antistatic, wide illuminance, and easy for cleaning.
- Uses HEME electronic ballast with high efficiency, energy saving and long service life.

Model specification list:

Model	Spec	Long (mm)	Wide (mm)	High (mm)	Packing Size (cm)	Quantities (pcs/ctn)
HMA-0431	3×40W	1250	450	100	128×48×23	2
	3×28W	1200	450	100	123×48×23	2



Brackets series with net

+ (86) 139 1020 7020

Features:

- Lamp body uses unique mesh-style plate design highly transparent PP film with soft and indirect lighting and no glare.
- Lamp body is made with 0.6mm high-quality high-strength steel sheet and undergoes rust removal,grease removal,and rustproof treatment,and full spray-coated treatment,no rust will appear for normal indoor use for above 8 years.
- Uses HEME electronic ballast with high efficiency,energy saving and long service life.

Model specification list:

Model	Spec	Long (mm)	Wide (mm)	High (mm)	Packing Size (cm)	Quantities (pcs/ctn)
HMS-1102	2×20W	650	180	50	67×23×20	4
	2×14W	610	180	50	64×23×20	4



Euro cleansing cast aluminum transverse plug-in accent lamp series

HMC-140A

+ (86) 186-8880-7020

Features:

- The lamp uses appearance and practicality patent, dual-ring surface die-cast aluminum surface design, pleasing to the eye and practical, and easy for mounting.
- Lamp body uses high-purity aluminum by die casting and imported 1mm electrolysis plate, the cast aluminum never rusting; and the electrolysis plate is pleasing to the eye and durable, and not liable to rusting.
- Reflector: made with imported high-purity 1mm aluminum with Taiwan techniques, anodized treatment, and no photochromic change for over 8 years under normal indoor use.
- Equipped with safety toughened glass shade, so the reflector could keep high light lighting output for a long run and play a cleaning role.
- Uses HEME inductive ballast or electronic ballast with efficiency, energy saving and long service life.

Model specification list:

Model	Spec	Exterior Size (mm)	High (mm)	Cut-out Φ (mm)	Packing Size (cm)	Quantities (pcs/ctn)
HMC-140A	4 inch 1×13W	157	100	145	75×36×50	24
	4 inch 1×10W	157	100	145	75×36×50	24



Built-in grid spot lamp series

+ (86) **HMX-001** 135 8880-7020

Features:

- The lamp uses dual-ring adjustable-angle design, wide illumination angle, wide application, pleasing to the eye and practical, and easy for mounting.
- Lamp bracket is made with high-purity aluminum alloy by die casting, undergoes treatment of grease removal and metallic paint spray-coated, and never rusting; the lamp bottom is made with 0.5mm high-strength steel sheet, undergoes rust removal, and dustproof treatment, and spray-coated in black color..
- Uses HEME electronic ballast with high efficiency, energy saving and long service life.

Model specification list:

Model	Spec	Exterior Size A (mm)	High H (mm)	Cut-out Φ (mm)	Packing Size (cm)	Quantities (pcs/ctn)
HMX-001	1×50W	205×205	130	180×180	65×43×28	12



Built-in lower-open lamp panel series

 **HMB-0415** + (86) 186-8880-7020

Features:

- The bottom plate uses new sloping bottom design, and could be used with ceiling keel of different types and structures.
- Lamp body is made with 0.6mm high-quality high-strength steel sheet and undergoes rust removal, grease removal, and rustproof treatment, and full spray-coated treatment, no rust will appear for normal indoor use for above 8 years.
- Reflector: Triangle design, spray-coted treatment, full-range reflection, no glare, even light distribution, wide illumination, elegant appearance.
- Uses HEME electronic ballast with high efficiency, energy saving and long service life.

Model specification list:

Model	Spec	Long (mm)	Wide (mm)	High (mm)	Cut-out A×B (mm)	Packing Size (cm)	Quantities (pcs/ctn)
HMB-0415	4×20W	598	598	85	580×580	64×63×19	2

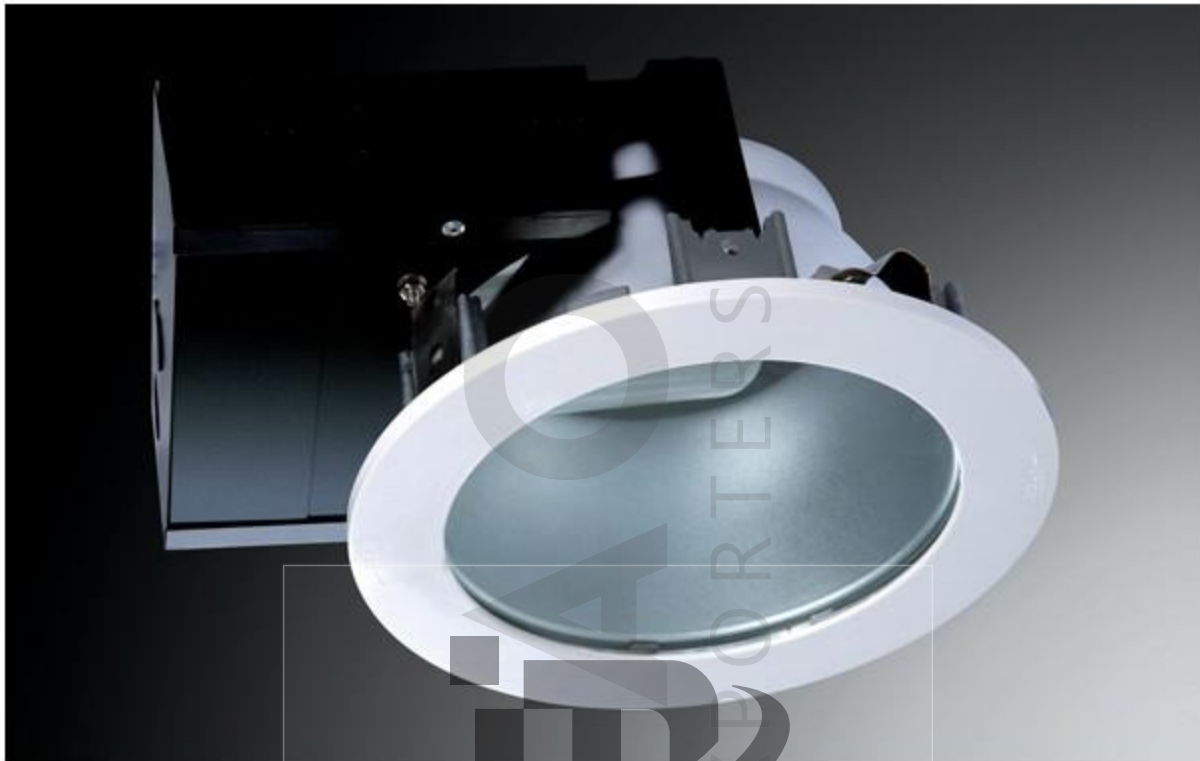

Euro 145-model PC cleansing accent lamp series HMC-145B (Black background)

Features:

- The lamp uses appearance and practicality patent, PC flame retardant plastic surface design, pleasing to the eye and practical, and easy for mounting.
- Lamp body uses integrated design, high-purity aluminum by die casting and 1mm high-quality steel plate, rust removal, grease removal, and rustproof treatment, full spray-coated treatment, and no rusting for over 8 years under normal indoor use; or made with 0.8mm stainless steel, and never rusting.
- Reflector: made with imported high-purity 1mm aluminum with Taiwan techniques, anodized treatment, and no photochromic change for over 8 years under normal indoor use.
- Equipped with safety toughened glass shade, so the reflector could keep high light lighting output for a long run and play a cleaning role.
- Uses HEME inductive ballast or electronic ballast with efficiency, energy saving and long service life.

Model specification list:

Model	Spec	Exterior Size (mm)	High (mm)	Cut-out Φ (mm)	Packing Size (cm)	Quantities (pcs/ctn)
HMC-145B	6 inch 2x18W	200	106	185	56x46x41	12
(Black background)	6 inch 2x13W	200	106	185	56x46x41	12



Ceiling wing-type space lamp panel series

+ (86) 186 8880-7020

Features:

- No-glare design,using secondary-reflection theory,bringht lighting but no glare
- Lamp body is made with 0.6mm high-quality high-strength steel sheet and undergoes rust removal,grease removal,and rustproof treatment,and full spray-coated treatment,no rust will appear for normal indoor use for above 8 years.
- Reflector:uning pure aluminum mesh,paracurve indirect reflection design,and avoid the glare.
- Uses HEME inductive ballast or electronic ballast with efficiency,energy saving and long service life.

Model specification list:

Model	Spec	Long (mm)	Wide (mm)	High (mm)	Packing Size (cm)	Quantities (pcs/ctn)
HML-0351	2×40W	1248	410	140	130×20×47	1
	2×28W	1198	410	140	126×20×47	1



Euro cleansing PC metal single-end halogen lamp series HMC-145TG

Features:

- The lamp uses appearance and practicality patent,dual-ring surface design,pleasing to the eye and practical,and easy for mounting. + (86) 186-8880-7020
- Lamp body uses high-purity aluminum by die casting and never rusting;the bracket uses imported electrolysis plate,not liable to rusting,and pleasing to the eye and practical.
- The ornamental ring of lamp hoop is made with die-cast aluminum or PC flame retardant material,no color change for a long run,white and environmental friendly,chean and pleasing to the eye,and equipped with safety toughened glass resistant to temperature of 360°C.
- Reflector:made with imported high-purity 1mm aluminum,anodized treatment,equipped with toughened glass resistant to temperature of 360°C,and no photochromic change for over 8 years under normal indoor use.
- Lamp holder:uses silica gel wire that is resistant to temperature of 300°C.
- Uses HEME electronic ballast with high efficiency,energy saving and long service life.

Model specification list:

Model	Spec	Exterior Size (mm)	High (mm)	Cut-out Φ (mm)	Packing Size (cm)	Quantitis (pcs/ctn)
HMC-145TG	6 inch 1×150W	200	240	185	60×43×52	8
	6 inch 1×70W	200	240	185	60×43×52	8



Industrial and miners lamp series

HMD-900

+ (86) 186-8880-7020

Features:

- Lamp body uses integrated design and high-quality aluminum alloy by die cast,rapid heat emission,resistant to high temperature and never rusting.
- Reflector:made with imported high-purity 1.5 mm aluminum,anodized treatment, and could be equipped with safety toughened glass or using PMMA transparent shade.
- Lamp holder:uses with imported radioceramic lamp holder that is resistant to temperaure of 800°C,and uess silica gel wire resistant to temperature of 300°C.
- Uses HEME inductive ballast,trigger,capacitor,high efficiency,energy,saving,and long service life.

Model specification lis:

Model	Spec	Exterior Size (mm)	High (mm)	Spec (cm)	Quantities (pcs/ctn)
HMD-900	1×400W	520	564	58×35×25	2
				shabe 55×55×70	8
	1×250W	480	564	58×35×25	2
				shabe 50×50×70	8



Built-in T5 I-model grid lamp panel series with net

HMT-0511

Features:

- T5 tube lamp is an internationally popular new type energy-saving lamp with the feature of high efficiency, energy saving, low power expenditure, and long service life, and saves above 30% of electric power than T8 luminous tube.
- The bottom plate uses new sloping bottom design, has a height of 55mm and extra-thin design, and could be used with ceiling keel of different types and structures.
- Lamp body is made with 0.6mm high-quality high-strength steel sheet and undergoes rust removal, grease removal, and rustproof treatment, and full spray-coated treatment, no rust will appear for normal indoor use for above 8 years.
- Reflector: web-plate paracurve reflector design, glare proof, wide illumination, made with imported German or American anodized mirror- or matt-surface aluminum, and no photochromic change for over 8 years under normal use.
- Uses HEME electronic ballast with high efficiency, energy saving and long service life.

Model specification list:

Model	Spec	Long (mm)	Wide (mm)	High (mm)	Cut-out A×B (mm)	Packing Size (cm)	Quantities (pcs/ctn)
HMT-0511	3×28W	1198	598	55	1180×580	123×62×14	2



Electronic ballast series for T8 luminous tube

+ (86) 156 3630-7020

Features:

- Metal power-spray casing, resistant to collision, fireproof, and resistance to corrosion.
- The key parts are imported high-quality parts of Samsung or Phillips etc.
- Stable output power, no stroboflash, and power factor higher than 0.95.
- Normal operation and stable performance under 150V-250V voltage and temperature of 10°C-60°C.
- Brand-new design, protective functions for over voltage and over current ect. and service life for above 5 years.
- Low harmonic wave design, so no disturbance to household electrical appliances, computers, communication, and office equipment.

Model specification list: :

Model	Spec	Working Voltage	Current(A)	Power Factor	Dimension (mm) (A×B×H)
HMF-20A	1×20W	220/50Hz	95	0.95	175×40×25

AL-1 25



Euro cleansing cast aluminum metal cross grid halogen lamp series

HMC-180A

Features:

+ (86) 186-8880-7020

- The lamp uses appearance and practicality patent,dual-ring surface die-cast aluminum surface design,pleasing to the eye and practical,and easy for mounting.
- Lamp body uses high-purity aluminum by die casting and imported 1mm electrolysis plate,the cast aluminum never rusting;and the electrolysis plate is pleasing to the eye and durable,and not liable to rusting.
- Reflector:made with imported high-purity 1mm aluminum with Taiwan techniques,anodized treatment,and no photochromic change for over 8 years under normal indoor use.
- Equipped with safety toughened glass shade ,so the reflector could keep high light lighting output for a long run and play a cleaning role.
- Uses HEME inductive ballast or electronic ballast with efficiency,energy saving and long service life.

Model specification list:

Model	Spec	Exterior Size (mm)	High (mm)	Cut-out Φ (mm)	Packing Size (cm)	Quantities (pcs/ctn)
HMC-180A	8 inch 2×26W	240	145	225	68×54×48	8
	8 inch 2×18W	240	145	225	68×54×48	8



Ordinary transverse plug-in fog-proof accent lamp series HMC-362AC

Features:

+ (86) 186-8880-7020

- The lamp uses appearance and practicality patent, dual-ring die-cast aluminum surface design, pleasing to the eye and practical, and easy for mounting.
- Lamp body uses high-purity aluminum by die casting and imported 1mm electrolysis plate, the cast aluminum never rusting; and the electrolysis plate is pleasing to the eye and durable, and not liable to rusting.
- Reflector: made with imported high-purity 1mm aluminum with Taiwan techniques, anodized treatment, and no photochromic change for over 8 years under normal indoor use.
- Uses HEME electronic ballast with high efficiency, energy saving and long service life.

Model specification list:

Model	Spec	Exterior Size (mm)	High (mm)	Cut-out Φ (mm)	Packing Size (cm)	Quantities (pcs/ctn)
HMC-362AC	6 inch 2×18W	195	110	170	65×44×38	12

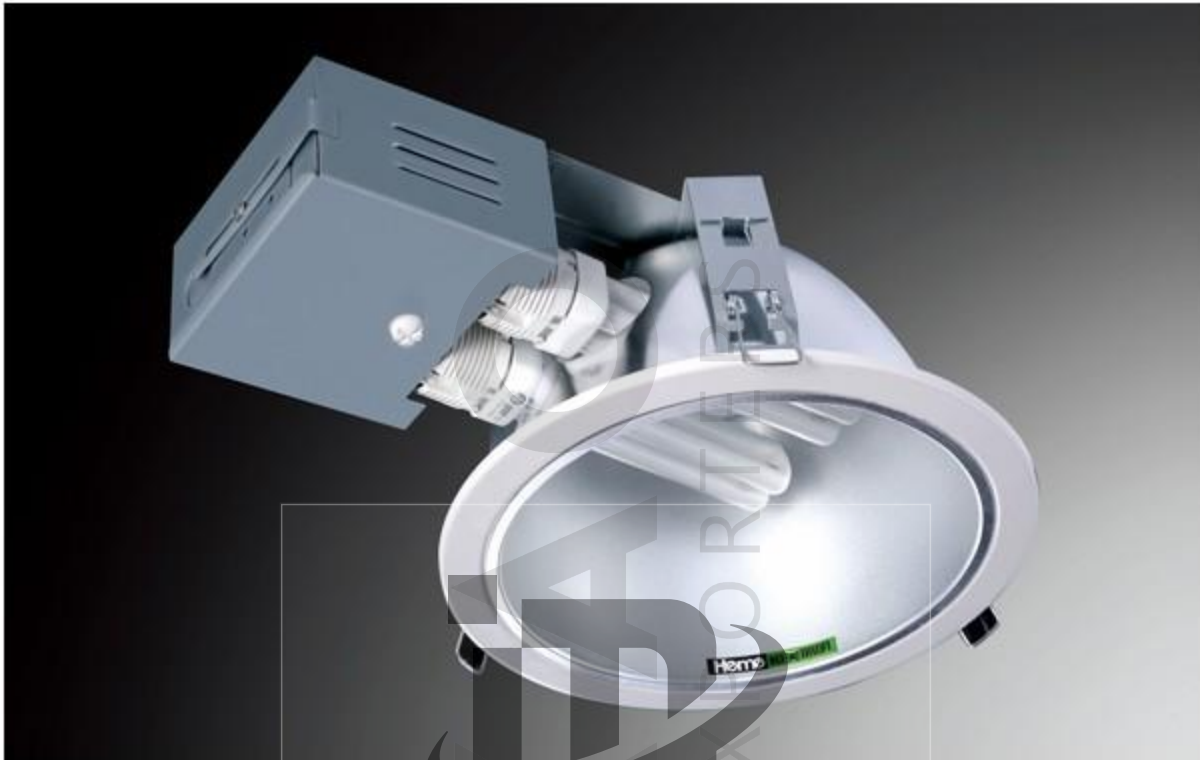

Ordinary transverse plug-in accent lamp series

HMC-382A

+ (86) 186-8880-7020

Features:

- Lamp body uses high-quality 1mm electrolysis plate,the cast practical,and easy for mounting .
- Reflector:made with imported high-purity 1mm aluminum with Taiwan techniques,and anodized treatment,and no photochromic change for over 8 years under normal indoor use.
- Uses HEME electronic ballast with high efficiency,energy saving and long service life.

Model specification list:

Model	Spec	Exterior Size (mm)	High (mm)	Cut-out Φ (mm)	Packing Size (cm)	Quantitis (pcs/ctn)
HMC-382A	8 inch 2×26W	240	130	210	60×38×54	8
	8 inch 2×18 W	240	130	210	60×38×54	8



Aluminum alloy wire-casing band bracket series

HMS-0180(2.44m)

Features:

- The lamp uses streamline paracurve arc design which could be connected to unlimited length,wide illumination area,pleasing to the eyes and durable,and reflection ratio of 85%.
- Lamp body and shade are made by compression moulding of high-purity aluminum alloy,anodized treatment or full spray-coated treatment,and never rusting.
- Uses HEME electronic ballast with high efficiency,energy saving and long service life.

Model specification list:

Model	Spec	Long (mm)	Wide (mm)	High (mm)	Packing Size (cm)	Quantities (pcs/ctn)
HMS-0180	2×40W	2440	180	100	249×24×13	6



Electronic ballast series for T8 luminous tube

HMF-20B
 +(86) 186 8880 7020

Features:

- Metal power-spray casing, resistant to collision, frieproof, and resistance to corrosion.
- The key parts are imported high-quality parts of Samsung or Phillips etc.
- Stable output power, no stroboflash, and power factor higher than 0.95.
- Normal operation and stable performance under 150V-250V voltage and temperature of 10°C-60°C.
- Bran-new design, protective functions for over voltage and over current ect. and service life for aboves 5 years.
- Low harmonic wave design, so no disturbance to household electrical appliances, computers, communication, and office equipment.

Model specification list :

Model	Spec	Working Voltage	Current(A)	Power Factor	Dimension (mm) (A×B×H)
HMF-20B	2×20W	220/50Hz	180	0.95	240×40×30

AL-1 30



Ceiling cleansing ivory-white organic sheet lamp panel series

+ (86) 186-8880-7020

Features:

- Uses special design, special rubber installed in-between lamp and transparent shade to acquire sealing effect, buckle spring design, and easy mounting and maintenance.
- Lamp body is made with 0.6mm high-quality high-strength steel sheet and undergoes rust removal, grease removal, and rustproof treatment, and full spray-coated treatment, no rust will appear for normal indoor use for above 8 years.
- Protecting shade: uses imported ivory-white sheet; light ratio of 75%, antistatic, wide illuminance, and easy for cleaning.
- Uses HEME electronic ballast with high efficiency, energy saving and long service life.

Model specification list:

Model	Spec	Long (mm)	Wide (mm)	High (mm)	Packing Size (cm)	Quantities (pcs/ctn)
HMA-0432	2×40W	1250	350	100	128×38×23	2
	2×28W	1200	350	100	123×38×23	2



T5 fluorescent lamp bracket series (flat cover)

+ (86) 186-8880-7020

HMS-T501

Features:

- The lamp use special streamline design for T5 luminous tube, small size, wide purpose, wide reflection surface, and easy for mounting.
- Lamp body is made with 0.5mm high-quality high-strength steel sheet and undergoes rust removal, grease removal, and rustproof treatment, and full spray-coated treatment, no rust will appear for normal indoor use for above 8 years.
- Uses HEME inductive ballast or electronic ballast with high efficiency, energy saving and long service life.

Model specification list (flat cover):

Model	Spec	Long (mm)	Wide (mm)	High (mm)	Packing Size (cm)	Quantities (pcs/ctn)
HMS-T501	1×28W	1170	40	35	120×19×12	12



Luxury ceiling lamp series

HMI-1822(32W)

Features:

- The lamp uses boss design, and keeps a distance from the ceiling for the purpose of heat emission from ballast and luminous tube.
- The lamp shade is made with imported PMMA material, good light transmittance, not liable to yellowing, not liable to dust absorption, easy for cleaning, and easy for mounting.
- The bottom plate is made with 0.6mm high-strength steel plate, rust removal, grease removal, and rustproof treatment, full spray-coated treatment, and no rusting for over 8 years under normal indoor use.
- Dustproof cushion is provided in between the bottom plate and lamp shade to avoid dust and small insects from getting inside the lamp shade and affecting on illumination effect.
- Uses HEME inductive ballast or electronic ballast with high efficiency, energy saving and long service life.
- Different flower patterns and exterior size are available for uses in different places.

Model specification list:

Model	Spec	Exterior Size (mm)	High (mm)	Packing Size (cm)	Quantities (pcs/ctn)
HMI-1822	1×32W	350	8	57×40×80	10
	1×28W	350	8	57×40×80	10
	1×22W	260	8	52×31.5×63.5	10

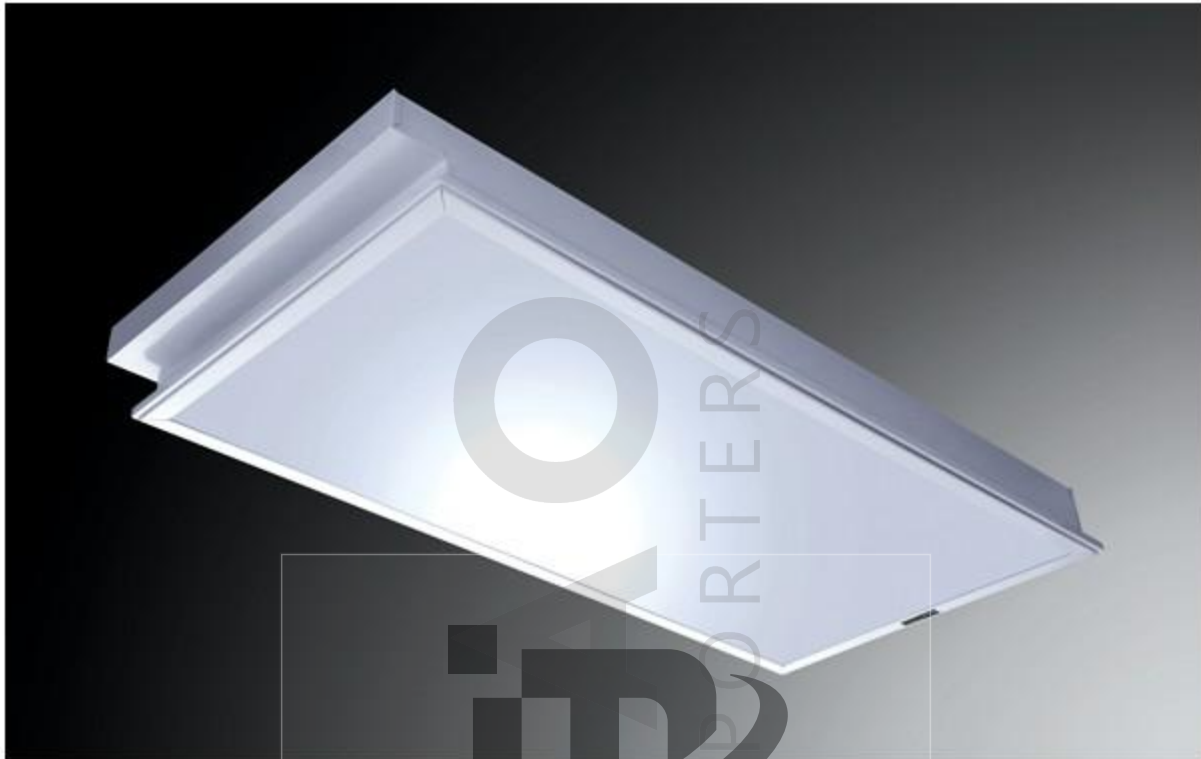

Built-in cleansing ivory-white organic sheet lamp panel series

HMB-0421

+ (86) 186-8880-7020

Features:

- Uses special design, special rubber installed in-between lamp and transparent shade to acquire sealing effect, buckle spring design, and easy mounting and maintenance.
- Lamp body is made with 0.6mm high-quality high-strength steel sheet and undergoes rust removal, grease removal, and rustproof treatment, and full spray-coated treatment, no rust will appear for normal indoor use for above 8 years.
- Protecting shade: uses imported ivory-white sheet; light ratio of 75%, antistatic, wide illuminance, and easy for cleaning.
- Uses HEME electronic ballast with high efficiency, energy saving and long service life.

Model specification list:

Model	Spec	Long (mm)	Wide (mm)	High (mm)	Cut-out A×B(mm)	Packing Size (cm)	Quantities (pcs/ctn)
HMB-0421	3×40W	1198	598	100	1180×580	126×63×23	2
	3×28W	1198	598	100	1180×580	126×63×23	2



Euro cleansing cast aluminum metal PLC42W halogen lamp series

HMC-188A Transverse

Features:

- The lamp uses appearance and practicality patent dual ring die-cast aluminum surface desing, design of special lamp for energy-saving luminous tube PLC32W-42W,pleasing to the eye and practical, and easy for mounting.
- Lamp body uses high-purity aluminum by die casting and imported 1mm electrolysis plate,the cast aluminum never rusting;and the electrolysis plate is pleasing to the eye and durable,and not liable to rusting.
- Reflector:made with imported high-purity 1mm aluminum with Taiwan techniqyes,anodized treatment,and no photochromic change for over 8 years under normal indooruse.
- Equipped with safety toughened glass shade ,so the reflector could keep high high lighting output for a long run and play a cleaning role.
- Uses HEME inductive ballast or electronic ballast with efficiency,energy saving and long service life.

Model specification list:

Model	Spec	Exterior Size (mm)	High (mm)	Cut-out Φ (mm)	Packing Size (cm)	Quantitis (pcs/ctn)
HMC-188A	8 inch 2×42W	240	145	225	60×38×54	8
Transverse	8 inch 2×32W	240	145	225	60×38×54	8



Euro diffuse reflection I-shape grid space lamp panel series with net

+ (86) 186 8880-7020

Features:

- Uses appearance and practicality patent, secondary reflection design, and has illumination strength 20% more than ordinary lamp.
- Lamp body is made with 0.6mm high-quality high-strength steel sheet and undergoes rust removal, grease removal, and rustproof treatment, and full spray-coated treatment, no rust will appear for normal indoor use for above 8 years.
- Reflector uses the latest light-distribution curve design, made with imported German or American anodized mirror-or matt -surface aluminum, and no photochromic change for over 8 years under normal indoor use.
- Uses HEME inductive ballast or electronic ballast with efficiency, energy saving and long service life.

Model specification list:

Model	Spec	Long (mm)	Wide (mm)	High (mm)	Cut-out A×B (mm)	Packing Size (cm)	Quantities (pcs/ctn)
HML-T5872	2×28W	1198	598	110	1180×580	123×63×24	2



Industrial and miners lamp series

HMD-888D1

+ (86) 186-8880-7020

Features:

- Lamp body uses integrated design and high-quality aluminum alloy by die cast,rapid heat emission,resistant to high temperature and never rusting.
- Reflector:made with imported high-purity 1.5 mm aluminum,anodized treatment, and could be equipped with safety toughened glass or using PMMA transparent shade.
- Lamp holder:uses with imported radioceramic lamp holder that is resistant to temperaure of 800°C,and uess silica gel wire resistant to temperature of 300°C.
- Uses HEME inductive ballast,trigger,capacitor,high efficiency,energy,saving,and long service life.

Model specification lis:

Model	Spec	Exterior Size (mm)	High (mm)	Spec (cm)	Quantities (pcs/ctn)
HMD-888D1	1×150W	395	430	50×35×25	2
	1×70W	395	430	shabe 50×50×51	8



Euro cleansing cast aluminum transverse plug-in accent lamp series

HMC-181A

Features:

+ (86) 186-8880-7020

- The lamp uses appearance and practicality patent,dual-ring surface die-cast aluminum surface design,pleasing to the eye and practical,and easy for mounting.
- Lamp body uses high-purity aluminum by die casting and imported 1mm electrolysis plate,the cast aluminum never rusting;and the electrolysis plate is pleasing to the eye and durable,and not liable to rusting.
- Reflector:made with imported high-purity 1mm aluminum with Taiwan techniques,anodized treatment,and no photochromic change for over 8 years under normal indoor use.
- Equipped with safety toughened glass shade ,so the reflector could keep high high lighting output for a long run and play a cleaning role.
- Uses HEME inductive ballast or electronic ballast with efficiency,energy saving and long service life.

Model specification list:

Model	Spec	Exterior Size (mm)	High (mm)	Cut-out Φ (mm)	Packing Size (cm)	Quantitis (pcs/ctn)
HMC-181A	8 inch 2×26W	240	130	225	60×38×54	8
	8 inch 2×18W	240	130	225	60×38×54	8

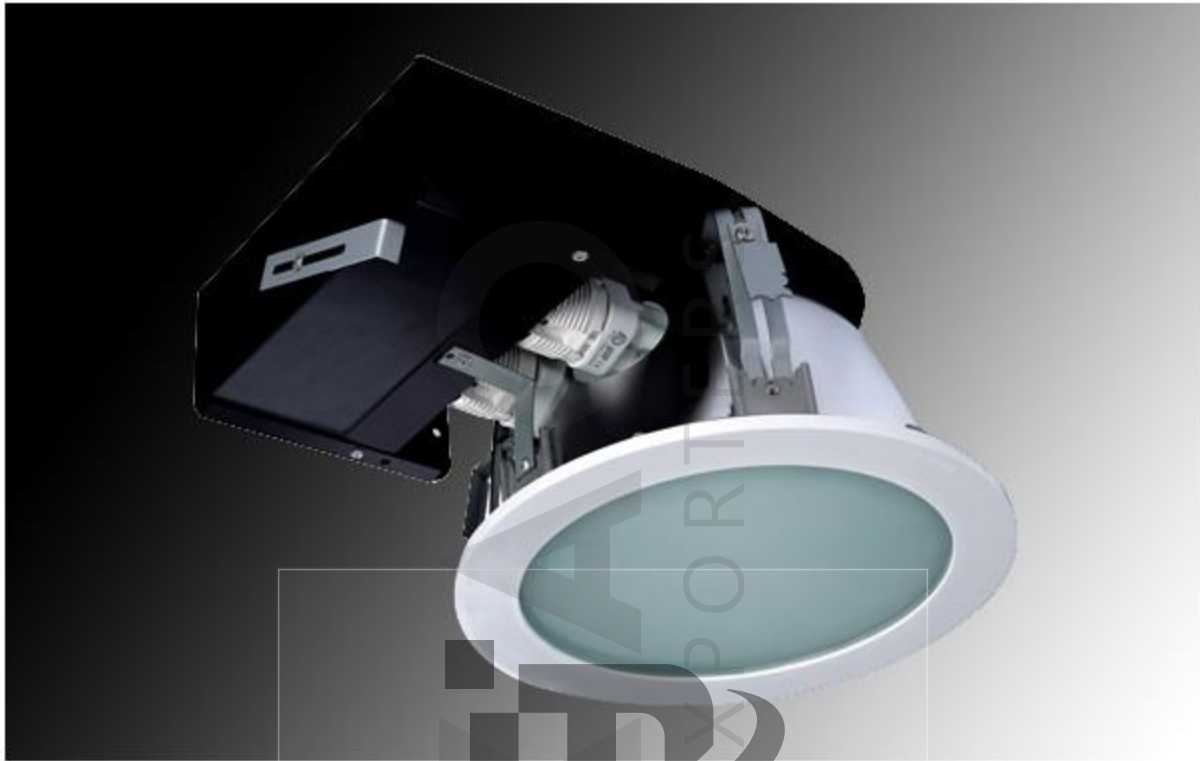

Euro cleansing PC PLC42W accent lamp series HMC-288A (Transverse)

Features:

- The lamp uses appearance and practicality patent, PC flame retardant plastic surface design, design of special lamp for energy-saving luminous tube PLC32W-42W, pleasing to the eye and practical, and easy for mounting.
- Lamp body uses high-quality 1mm electrolysis plate, the cast practical, and easy for mounting .
- Reflector: made with imported high-purity 1mm aluminum with Taiwan techniques, anodized treatment, and no photochromic change for over 8 years under normal indoor use.
- Equipped with safety toughened glass shade ,so the reflector could keep high light lighting output for a long run and play a cleaning role.
- Uses HEME inductive ballast or electronic ballast with efficiency, energy saving and long service life.

Model specification list:

Model	Spec	Exterior Size (mm)	High (mm)	Cut-out Φ (mm)	Packing Size (cm)	Quantities (pcs/ctn)
HMC-288A	8 inch 2×42W	240	145	225	60×38×54	8
(Transverse)	8 inch 2×32W	240	145	225	60×38×54	8

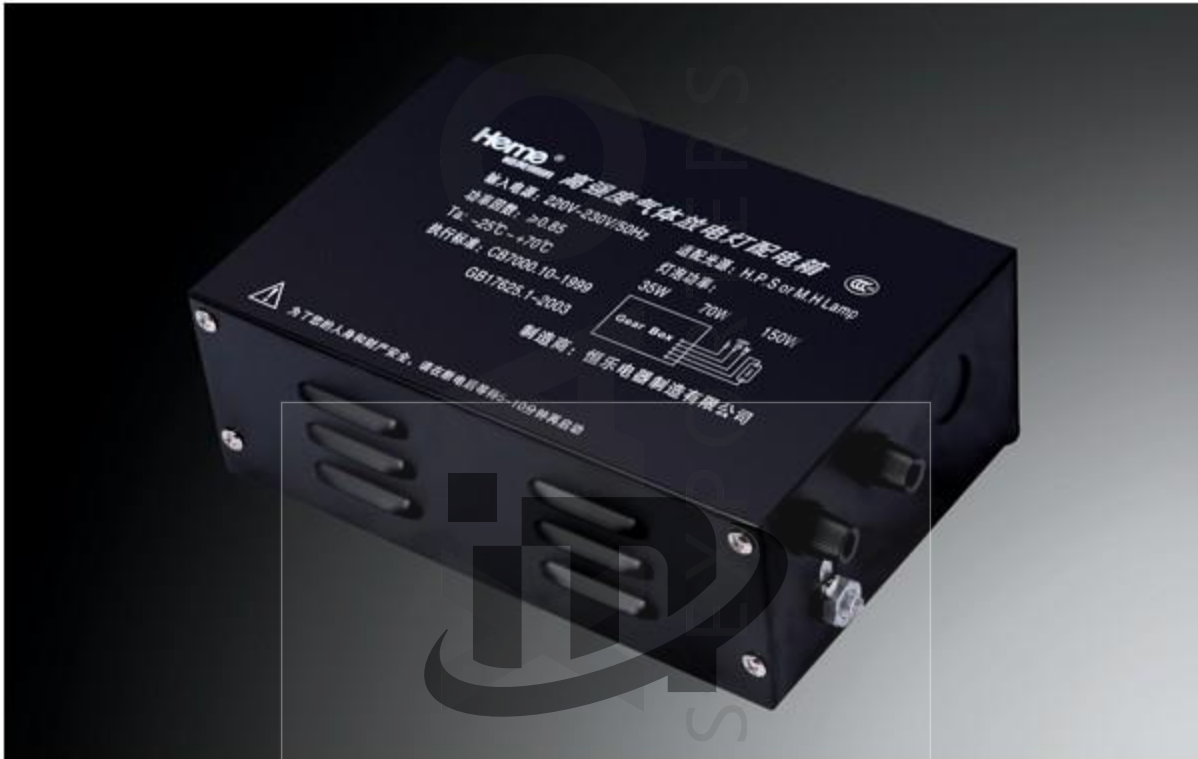

+ (86) 186-8880-7020

Electrical box series for metal halogen lamp

HMG-1250

Features:

- Electrical box metal halogen lamp of integrated design and easy for mounting.
- Equipped inside with inductive ballst,trigger,and capacitor.
- Low temperature rise,noiseless,and power factor above 0.9.

Model specification list:

Model	Spec	Long (mm)	Wide (mm)	High(mm)	Packing Size (cm)	Quantitis (pcs/ctn)
HMG-1250	250W	200	140	80	49×32×19	8



Ordinary vertical plug-in accent lamp series

+ (86) 186 8880-7020

Features:

- Lamp body uses high-quality 1mm electrolysis plate,the cast practical,and easy for mounting .
- Reflector:made with imported high-purity 1mm aluminum with Taiwant techniques,andodized treatment,and no photochromic change for over 8 years under normal indoor use.
- Uses HEME electronic ballast with high efficiency,energy saving and long service life.

Model specification list:

Model	Spec	Exterior Size (mm)	High (mm)	Cut-out Φ (mm)	Packing Size (cm)	Quantitis (pcs/ctn)
HMC-341B	4 inch 1×E27	145	170	130	65×50×39	24



Electronic ballast series for T5 luminous tube

☎ **HMF-28A** + (86) 156 8880-7020

Features:

- Metal power-spray casing, resistant to collision, fireproof, and resistance to corrosion.
- The key parts are imported high-quality parts of Samsung or Phillips etc.
- Stable output power, no stroboflash, and power factor higher than 0.95.
- Normal operation and stable performance under 150V-250V voltage and temperature of 10°C-60°C.
- Brand-new design, protective functions for over voltage and over current ect. and service life for above 5 years.
- Low harmonic wave design, so no disturbance to household electrical appliances, computers, communication, and office equipment.

Model specification list :

Model	Spec	Working Voltage	Current(A)	Power Factor	Dimension (mm) (A×B×H)
HMF-28A	1×28W	220/50Hz	134	0.95	240×25×25



Industrial and miners lamp series

HMD-888D3

+ (86) 186-8880-7020

Features:

- Lamp body uses integrated design and high-quality aluminum alloy by die cast,rapid heat emission,resistant to high temperature and never rusting.
- Reflector:made with imported high-purity 1.5 mm aluminum,anodized treatment, and could be equipped with safety toughened glass or using PMMA transparent shade.
- Lamp holder:uses with imported radioceramic lamp holder that is resistant to temperaure of 800°C,and uess silica gel wire resistant to temperature of 300°C.
- Uses HEME inductive ballast,trigger,capacitor,high efficiency,energy,saving,and long service life.

Model specification lis:

Model	Spec	Exterior Size (mm)	High (mm)	Spec (cm)	Quantities (pcs/ctn)
HMD-888D3	1×250W	480	507	50×35×25	2
	1×150W	480	507	shabe 50×50×51	8



Euro T8 fluorescent lamp bracket series(flat cover)

+ (86) 186 8880-7020

HMS-0130

Features:

- The lamp uses streamline design,wide illumination area,brevity and pleasing to the eye,wide application ,and easy for mounting.
- Lamp body is made with 0.5mm high-quality high-strength steel sheet and undergoes rust removal,grease removal,and rustproof treatment,and full spray-coated treatment,no rust will appear for normal indoor use for above 8 years.
- Uses HEME electronic ballast with high efficiency,energy saving and long service life.

Model specification list(flat cover):

Model	Spec	Long (mm)	Wide (mm)	High (mm)	Packing Size (cm)	Quantities (pcs/ctn)
HMS-0130	2×40W	1230	100	80	126×23×14	12



Euro cleansing PC metal dual-end halogen lamp series HMC-208T

Features:

- The lamp uses appearance and practicality patent,dual-ring surface design,pleasing to the eye and practical,and easy for mounting.
- Lamp body uses high-purity aluminum by die casting and never rusting;the bracket uses imported electrolysis plate,not liable to rusting,and pleasing to the eye and practical.
- The ornamental ring of lamp hoop is made with die-cast aluminum or PC flame retardant material,no color change for a long run,white and environmental friendly,chean and pleasing to the eye,and equipped with safety toughened glass resistant to temperature of 360°C.
- Reflector:made with imported high-purity 1mm aluminum,anodized treatment,equipped with toughened glass resistant to temperature of 360°C,and no photochromic change for over 8 years under normal indoor use.
- Lamp holder:uses silica gel wire that is resistant to temperature of 300°C.
- Uses HEME electronic ballast with high efficiency,energy saving and long service life.

Model specification list:

Model	Spec	Exterior Size (mm)	High (mm)	Cut-out Φ (mm)	Packing Size (cm)	Quantitis (pcs/ctn)
HMC-208T	8 inch 1×150W	240	250	225	70×53×53	8
	8 inch 1×70W	240	250	225	70×53×53	8



Ordinary transverse plug-in cross-type accent lamp series

+ (86) 186-8880-7020

HMC-361A

Features:

- Lamp body uses high-quality 1mm electrolysis plate,the cast practical,and easy for mounting .
- Reflector:made with imported high-purity 1mm aluminum with Taiwant techniques,andodized treatment,and no photochromic change for over 8 years under normal indoor use.
- Uses HEME electronic ballast with high efficiency,energy saving and long service life.

Model specification list:

Model	Spec	Exterior Size (mm)	High (mm)	Cut-out Φ (mm)	Packing Size (cm)	Quantitis (pcs/ctn)
HMC-361A	6inch1×18W	195	100	170	65×44×38	12
	6寸2×18W	195	100	170	65×44×38	12



Euro cleansing PC metal single-end halogen lamp series

HMC-225TG

Features:

- The lamp uses appearance and practicality patent,dual-ring surface design,pleasing to the eye and practical,and easy for mounting.
- Lamp body uses high-purity aluminum by die casting and never rusting;the bracket uses imported electrolysis plate,not liable to rusting,and pleasing to the eye and practical.
- The ornamental ring of lamp hoop is made with die-cast aluminum or PC flame retardant material,no color change for a long run,white and environmental friendly,chean and pleasing to the eye,and equipped with safety toughened glass resistant to temperature of 360°C.
- Reflector:made with imported high-purity 1mm aluminum,anodized treatment,equipped with toughened glass resistant to temperature of 360°C,and no photochromic change for over 8 years under normal indoor use.
- Lamp holder:uses silica gel wire that is resistant to temperature of 300°C.
- Uses HEME electronic ballast with high efficiency,energy saving and long service life.

Model specification list:

Model	Spec	Exterior Size (mm)	High (mm)	Cut-out Φ (mm)	Packing Size (cm)	Quantitis (pcs/ctn)
HMC-225TG	5 inch 1×150W	185	200	170	58×42×50	8
	5 inch 1×35W	185	200	170	58×42×50	8



Euro cleansing PC transverse plug-in accent lamp series HMC-250A

Features:

- The lamp uses appearance and practicality patent,PC flame retardant plastic surface design,pleasing to the eye and practical,and easy for mounting.
- Lamp body uses high-quality 1mm electrolysis plate,the cast practical,and easy for mounting .
- Reflector:made with imported high-purity 1mm aluminum with Taiwan techniques,anodized treatment,and no photochromic change for over 8 years under normal indoor use.
- Equipped with safety toughened glass shade ,so the reflector could keep high light lighting output for a long run and play a cleaning role.
- Uses HEME inductive ballast or electronic ballast with efficiency,energy saving and long service life.

+ (86) 186-8880-7020

Model specification list:

Model	Spec	Exterior Size (mm)	High (mm)	Cut-out Φ (mm)	Packing Size (cm)	Quantities (pcs/ctn)
HMC-250A	5 inch 2x13W	185	100	170	53x40x38	12



Euro cleansing cast aluminum metal cross grid halogen lamp series

HMC-162A

Features:

- The lamp uses appearance and practicality patent,dual-ring surface die-cast aluminum surface design,pleasing to the eye and practical,and easy for mounting.
- Lamp body uses high-purity aluminum by die casting and imported 1mm electrolysis plate,the cast aluminum never rusting;and the electrolysis plate is pleasing to the eye and durable,and not liable to rusting.
- Reflector:made with imported high-purity 1mm aluminum with Taiwan techniques,anodized treatment,and no photochromic change for over 8 years under normal indoor use.
- Equipped with safety toughened glass shade ,so the reflector could keep high light lighting output for a long run and play a cleaning role.
- Uses HEME inductive ballast or electronic ballast with efficiency,energy saving and long service life.

Model specification list:

Model	Spec	Exterior Size (mm)	High (mm)	Cut-out Φ (mm)	Packing Size (cm)	Quantities (pcs/ctn)
HMC-162A	6 inch 2×18W	200	110	185	56×44×38	12
	6 inch 2×13W	200	110	185	56×44×38	12



Ceiling energy-saving cleansing with shade lamp panel series

HMB-0361

+ (86) 186-8880-7020

Feature:

- Uses special design,special rubber installed in-between lamp and transparent shade to acquire sealing effect,buckle spring design,and easy mounting and maintenance.
- Lamp body is made with 0.6mm high-quality high-strength steel sheet or aluminum alloy and undergoes rust removal,grease removal,and rustproof treatment ,and full spray-coated treatment,no rust will appear for normal indoor uses for above 8 years.
- Protecting shade:PMMA transparent sheet;reflector:uses at-wing shape design,even lighting,no glare,made with imported German or American anodized mirror-or matt-surface aluminum,and no photochromic change for over 8 years under normal uses.
- Uses HEME electronic ballast with high efficiency,energy saving and long service life.

Model specification list:

Model	Spec	Long (mm)	Wide (mm)	High (mm)	Packing Size (cm)	Quantities (pcs/ctn)
HMB-0361	3×40W	1250	450	100	128×48×23	2
	3×28W	1200	450	100	123×48×23	2

AL-1 50

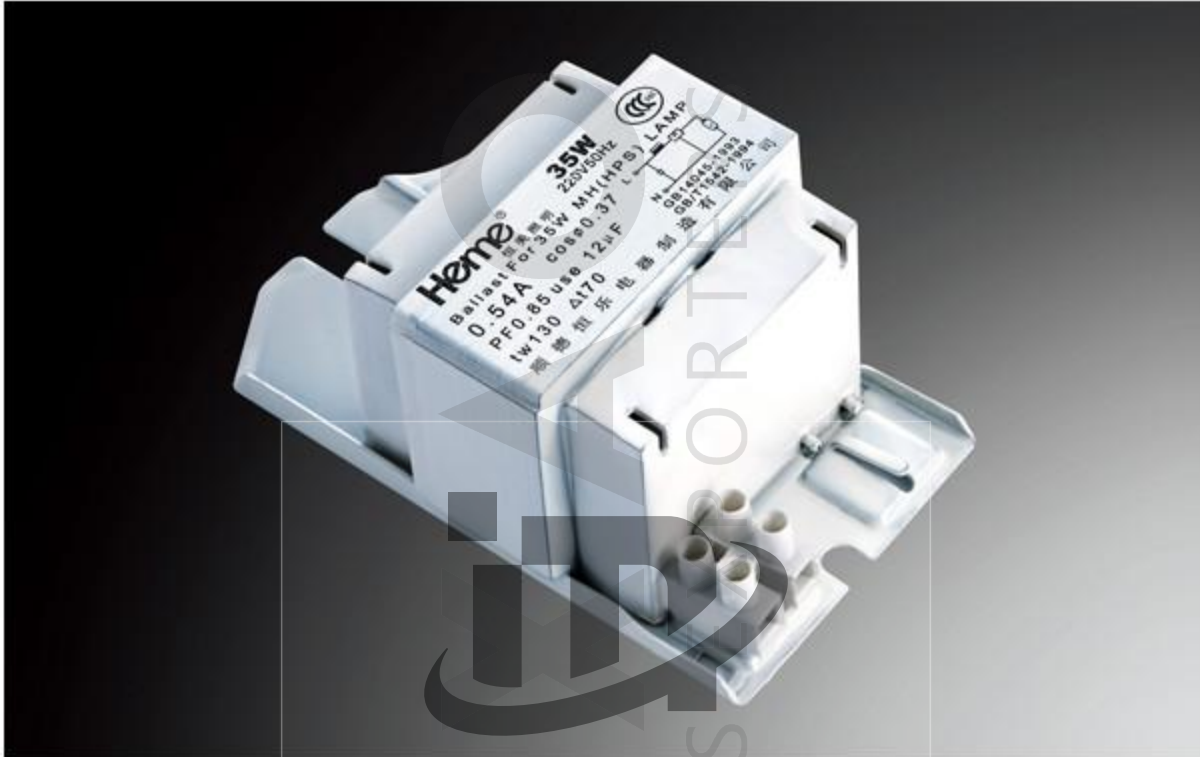

Inductive ballast series for metal halogen lamp

HMK-35

Features:

- Uses high-quality silicon steel sheet,low temperature rise,and small power consumption.
- Uses high-quality enameled wire,good heat resistance,maximum working temperature of 120°C allowed,and stable performance.
- Uses vacuum dip-painting technique,super noiselessness,and long service life for 10 years.

Model specification list:

Model	Spec	Working Voltage	COS Input	Current (A)	Dimension (mm) (A×B×H)
HMK-35	35W	220/50Hz	0.37	0.53	115×65×53



Euro cleansing PC metal dual-end halogen lamp series HMC-145T

Features:

- The lamp uses appearance and practicality patent,dual-ring surface design,pleasing to the eye and practical,and easy for mounting.
- Lamp body uses high-purity aluminum by die casting and never rusting;the bracket uses imported electrolysis plate,not liable to rusting,and pleasing to the eye and practical.
- The ornamental ring of lamp hoop is made with die-cast aluminum or PC flame retardant material,no color change for a long run,white and environmental friendly,chean and pleasing to the eye,and equipped with safety toughened glass resistant to temperature of 360°C.
- Reflector:made with imported high-purity 1mm aluminum,anodized treatment,equipped with toughened glass resistant to temperature of 360°C,and no photochromic change for over 8 years under normal indoor use.
- Lamp holder:uses silica gel wire that is resistant to temperature of 300°C.
- Uses HEME electronic ballast with high efficiency,energy saving and long service life.

Model specification list:

Model	Spec	Exterior Size (mm)	High (mm)	Cut-out Φ (mm)	Packing Size (cm)	Quantitis (pcs/ctn)
HMC-145T	6 inch 1×150W	200	240	185	60×43×52	8
	6 inch 1×70W	200	240	185	60×43×52	8



Euro 059-model accent lamp series

HMC-059A Light sand

+ (86) 186-8880-7020

Features:

- The lamp uses intergrated design,design of special lamp for energy-saving luminous tube PLC26W-42W,pleasing to the eye and practical,and easy for mounting.
- Lamp body uses high-quality 1mm electrolysis plate,the cast practical,and easy for mounting .
- Reflector:made with imported high-purity 1mm aluminum with Taiwant techniques,anodized treatment,and no photochromic change for over 8 years under normal indoor use.
- Uses HEME inductive ballast or electronic ballast with efficiency,energy saving and long service life.

Model specification list:

Model	Spec	Exterior Size (mm)	High (mm)	Cut-out Φ (mm)	Packing Size (cm)	Quantitis (pcs/ctn)
HMC-059A	9 inch 2×42W	256	132	240	60×58×38	8



Ceiling wing-type space lamp panel series

+86 186 26530 7020

Features:

- No-glare design,using secondary-reflection theory,bright lighting but no glare
- Lamp body is made with 0.6mm high-quality high-strength steel sheet and undergoes rust removal,grease removal,and rustproof treatment,and full spray-coated treatment,no rust will appear for normal indoor use for above 8 years.
- Reflector:uning pure aluminum mesh,paracurve indirect reflection design,and avoid the glare.
- Uses HEME inductive ballast or electronic ballast with efficiency,energy saving and long service life.

Model specification list:

Model	Spec	Long (mm)	Wide (mm)	High (mm)	Packing Size (cm)	Quantities (pcs/ctn)
HML-0353	2×20W	639	410	140	70×20×47	1
	2×14W	598	410	140	67×20×47	1



Luxury ceiling lamp series

HMI-1720

Features:

- The lamp uses boss design, and keeps a distance from the ceiling for the purpose of heat emission from ballast and luminous tube.
- The lamp shade is made with imported PMMA material, good light transmittance, not liable to yellowing, not liable to dust absorption, easy for cleaning, and easy for mounting.
- The bottom plate is made with 0.6mm high-strength steel plate, rust removal, grease removal, and rustproof treatment, full spray-coated treatment, and no rusting for over 8 years under normal indoor use.
- Dustproof cushion is provided in between the bottom plate and lamp shade to avoid dust and small insects from getting inside the lamp shade and affecting on illumination effect.
- Uses HEME inductive ballast or electroic ballast with high efficiency, energy saving and long service life.
- Different flower patterns and exterior size are available for uses in different places.

Model specification list:

Model	Spec	Exterior Size (mm)	High (mm)	Packing Size (cm)	Quantitis (pcs/ctn)
HMI-1720	1×40W	450	9	75×48×48	8
	1×32W	450	9	75×48×48	8



Euro diffuse reflection V-shape grid space lamp panel series with net

 **HML-T5883** + (86) 186 8880-7020

Features:

- Uses appearance and practicality patent,secondary reflection design,and has illumination strenght 20% more than ordinary lamp.
- Lamp body is made with 0.6mm high-quality high-strength steel sheet and undergoes rust removal,grease removal,and rustproof treatment,and full spray-coated treatment,no rust will appear for normal indoor use for above 8 years.
- Reflector uses the latest light-distribution curve design,made with imported German or American anodized mirror-or matt -surface aluminum,and no photochroic change for over 8 years under normal indoor use.
- Uses HEME inductive ballast or electronic ballast with efficiency,energy saving and long service life.

Model specification list:

Model	Spec	Long (mm)	Wide (mm)	High (mm)	Cut-out A×B (mm)	Packing Size (cm)	Quantities (pcs/ctn)
HML-T5883	4×14W	598	598	110	580×580	63×63×24	2



Built-in energy-saving cleansing with shade lamp panel series

HMB-0372

+ (86) 186-8880-7020

Feature:

- Uses special design,special rubber installed in-between lamp and transparent shade to acquire sealing effect,buckle spring design,and easy mounting and maintenance.
- Lamp body is made with 0.6mm high-quality high-strength steel sheet or aluminum alloy and undergoes rust removal,grease removal,and rustproof treatment ,and full spray-coated treatment,no rust will appear for normal indoor uses for above 8 years.
- Protecting shade:PMMA transparent sheet;reflector:uses at-wing shape design,even lighting,no glare,made with imported German or American anodized mirror-or matt-surface aluminum,and no photochromic change for over 8 years under normal uses.
- Uses HEME electronic ballast with high efficiency,energy saving and long service life.

Model specification list:

Model	Spec	Long (mm)	Wide (mm)	High (mm)	Cut-out A×B (mm)	Packing Size (cm)	Quantities (pcs/ctn)
HMB-0372	2×40W	1198	298	100	1180×280	126×32×23	2
	2×28W	1198	298	100	1180×280	123×32×23	2



Inductive ballast series for metal halogen lamp

HMK-70

Features:

- Uses high-quality silicon steel sheet,low temperature rise,and small power consumption.
- Uses high-quality enameled wire,good heat resistance,maximum working temperature of 120°C allowed,and stable performance.
- Uses vacuum dip-painting technique,super noiselessness,and long service life for 10 years.

Model specification list:

Model	Spec	Working Voltage	COS Input	Current (A)	Dimension (mm) (A×B×H)
HMK-70	70W	220/50Hz	0.37	1.00	115×65×53



Ordinary transverse plug-in fog-proof accent lamp series HMC-381AC

Features:

- The lamp uses appearance and practicality patent, dual-ring die-cast aluminum surface design, pleasing to the eye and practical, and easy for mounting.
- Lamp body uses high-purity aluminum by die casting and imported 1mm electrolysis plate, the cast aluminum never rusting; and the electrolysis plate is pleasing to the eye and durable, and not liable to rusting.
- Reflector: made with imported high-purity 1mm aluminum with Taiwan techniques, anodized treatment, and no photochromic change for over 8 years under normal indoor use.
- Uses HEME electronic ballast with high efficiency, energy saving and long service life.

Model specification list:

Model	Spec	Exterior Size (mm)	High (mm)	Cut-out Φ (mm)	Packing Size (cm)	Quantities (pcs/ctn)
HMC-381AC	8 inch 2×26W	240	140	210	60×38×54	8
	8 inch 2×18W	240	140	210	60×38×54	8



Luxury ceiling lamp series

HMI-1620

Features:

- The lamp uses boss design, and keeps a distance from the ceiling for the purpose of heat emission from ballast and luminous tube.
- The lamp shade is made with imported PMMA material, good light transmittance, not liable to yellowing, not liable to dust absorption, easy for cleaning, and easy for mounting.
- The bottom plate is made with 0.6mm high-strength steel plate, rust removal, grease removal, and rustproof treatment, full spray-coated treatment, and no rusting for over 8 years under normal indoor use.
- Dustproof cushion is provided in between the bottom plate and lamp shade to avoid dust and small insects from getting inside the lamp shade and affecting on illumination effect.
- Uses HEME inductive ballast or electroic ballast with high efficiency, energy saving and long service life.
- Different flower patterns and exterior size are available for uses in different places.

Model specification list:

Model	Spec	Exterior Size (mm)	High (mm)	Packing Size (cm)	Quantitis (pcs/ctn)
HMI-1620	1×60W	580	12	62×62×72	6
	1×72W	580	12	62×62×72	6

AL-1 60

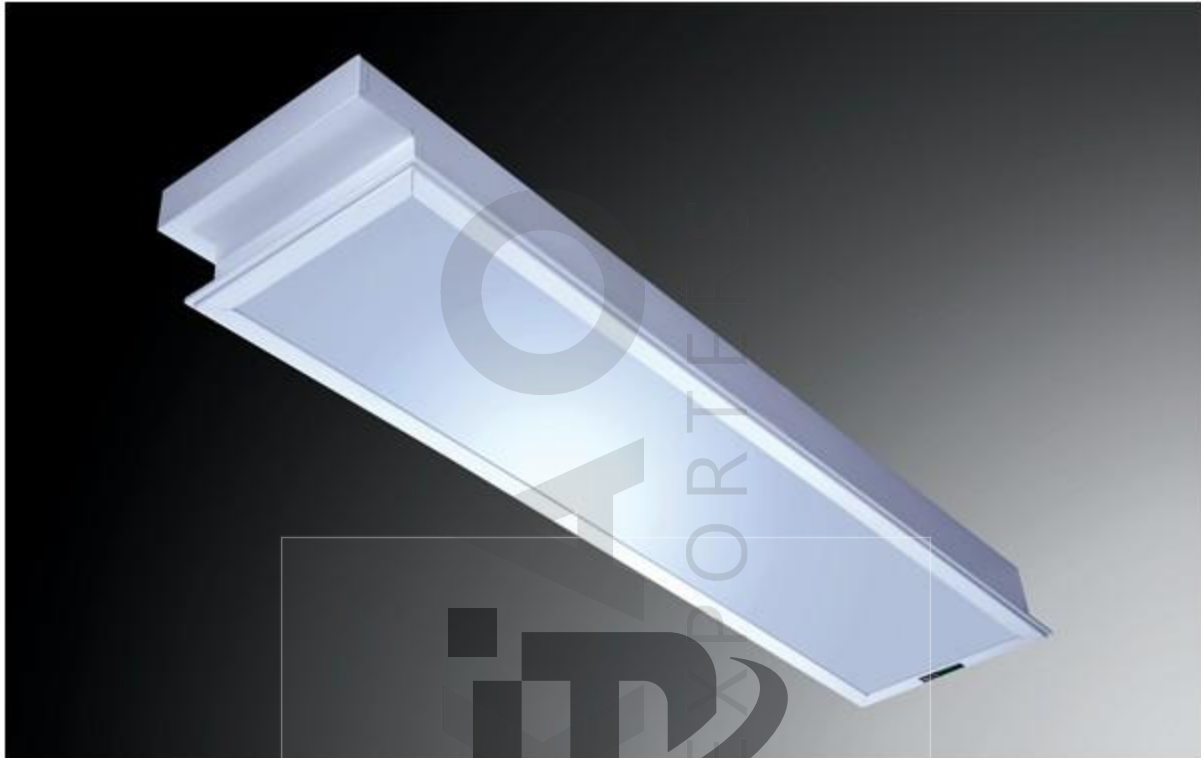

Built-in cleansing ivory-white organic sheet lamp panel series

HMB-0422

+ (86) 186-8880-7020

Features:

- Uses special design, special rubber installed in-between lamp and transparent shade to acquire sealing effect, buckle spring design, and easy mounting and maintenance.
- Lamp body is made with 0.6mm high-quality high-strength steel sheet and undergoes rust removal, grease removal, and rustproof treatment, and full spray-coated treatment, no rust will appear for normal indoor use for above 8 years.
- Protecting shade: uses imported ivory-white sheet; light ratio of 75%, antistatic, wide illuminance, and easy for cleaning.
- Uses HEME electronic ballast with high efficiency, energy saving and long service life.

Model specification list:

Model	Spec	Long (mm)	Wide (mm)	High (mm)	Cut-out A×B (mm)	Packing Size (cm)	Quantities (pcs/ctn)
HMB-0422	2×40W	1198	298	100	1180×280	126×32×23	2
	2×28W	1198	298	100	1180×280	126×32×23	2

BHBH{KNMI~9W[8@~7O90J3X

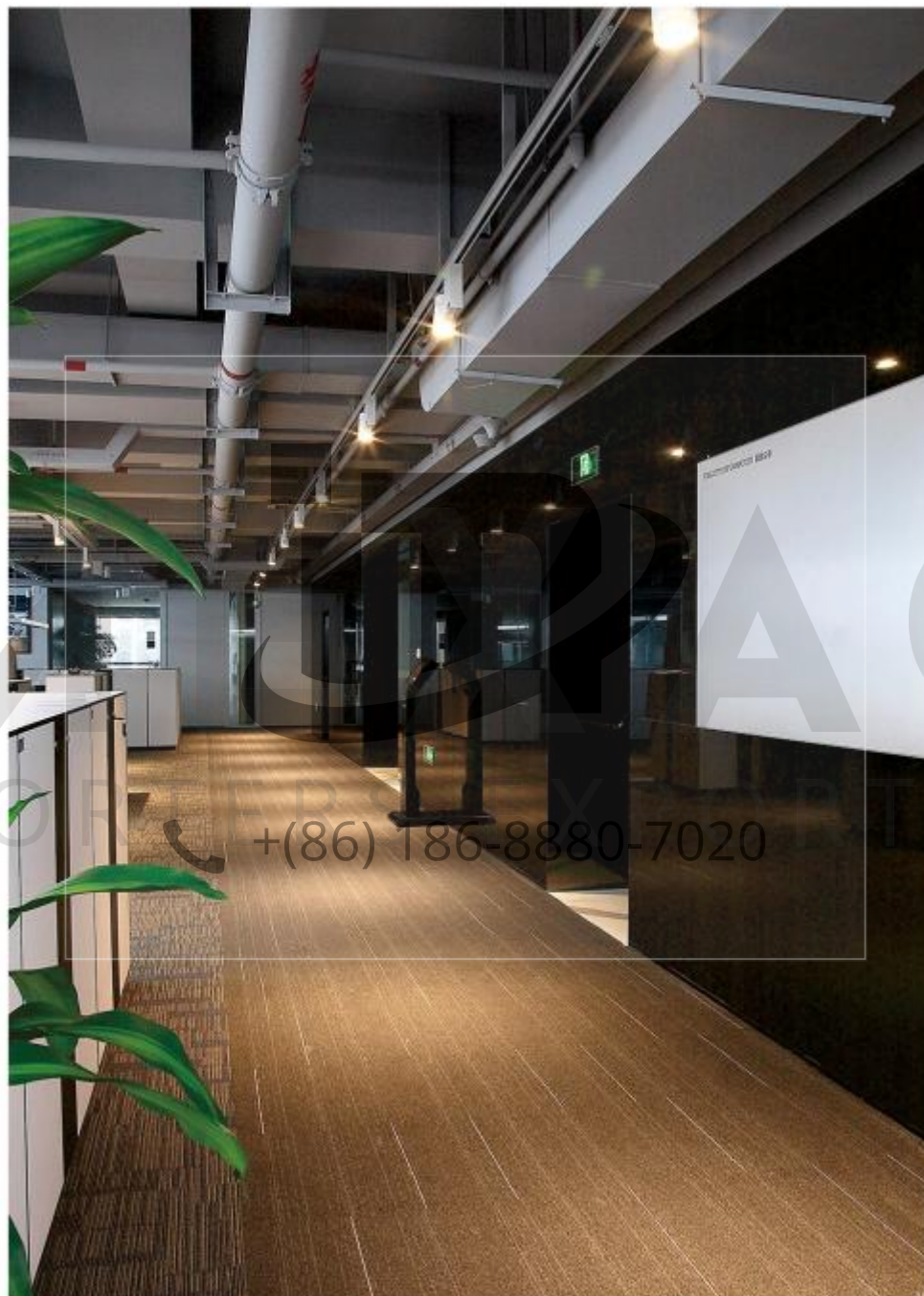

AL-2 1



"Let us help to build your dreams"

Kangcai 康彩



LED 光源

060025

Luminaire Property (主要参数)

Light source(光源)	COB
Power(功率)	30W
Beam angle(光束角度)	12°/20°
Color temperature(色温)	3000K/4000K/6000K
Light efficiency(光效)	>80lm/W
Color rendering index(显色指数)	Ra≥80
Operating temperature(环境温度)	-25-+40
Rated life hours(工作寿命)	35,000-50,000H
LED Chip(芯片)	CREE  EPISTAR



+(86)-186-8880-7020



Color(灯体外观颜色选择)



银色



白色

LED driver (include)(LED驱动)

Output voltage(输出电压)	36-40V
Output current(输出电流)	800mA

AL-2 2



"Let us help to build your dreams"

Kangcai 康彩



LED 光源

060022

Luminaire Property (主要参数)

Light source(光源)	COB
Power(功率)	15W
Beam angle(光束角度)	60°
Color temperature(色温)	3000K/4000K/6000K
Light efficiency(光效)	>80lm/W
Color rendering index(显色指数)	Ra≥80
Operating temperature(环境温度)	-25-+40
Rated life hours(工作寿命)	35,000-50,000H
LED Chip(芯片)	EPISTAR



RoHS



IP20



+ (86) 186-8880-7020



IMPORTERS EXPORTERS

Color(灯体外观颜色选择)



银色

LED driver (include)(LED驱动)

Output voltage(输出电压)	30-33V
Output current(输出电流)	450mA

AL-2 3

 **IMEXAO**
IMPORTERS EXPORTERS

"Let us help to build your dreams"

LED 光源

060023



Luminaire Property (主要参数)

Light source(光源)	COB
Power(功率)	20W/30W
Beam angle(光束角度)	15°
Color temperature(色温)	3000K/4000K/6000K
Light efficiency(光效)5	>80lm/W
Color rendering index(显色指数)	Ra≥80
Operating temperature(环境温度)	-25~+40
Rated life hours(工作寿命)	35,000-50,000H
LED Chip(芯片)	EPISTAR



+ (86) 186-8880-7020



Color(灯体外观颜色选择)



哑光白

LED driver (include)(LED驱动)

Output voltage(输出电压)	36-40V
Output current(输出电流)	550mA(20W) 800mA(30W)

AL-2 4



"Let us help to build your dreams"

LED 光源

060015

Kangcai 康彩



Luminaire Property (主要参数)

Light source(光源)	SMD
Power(功率)	35W
Beam angle(光束角度)	20°
Color temperature(色温)	3000K/4000K/6000K
Light efficiency(光效)	>80lm/W
Color rendering index(显色指数)	Ra≥80
Operating temperature(环境温度)	-25 -+40
Rated life hours(工作寿命)	35,000-50,000H
LED Chip(芯片)	OSRAM



+ (86) 186-8880-7020



Color(灯体外观颜色选择)



暖光白

LED driver (include)(LED驱动)

Output voltage(输出电压)	36-40V
Output current(输出电流)	800mA

AL-2 5

 **IMEXAO**
IMPORTERS EXPORTERS

"Let us help to build your dreams"

LED 光源

060016

Kangcai 康彩



Luminaire Property (主要参数)

Light source(光源)	COB
Power(功率)	35W
Beam angle(光束角度)	10°/15°/24°/40°
Color temperature(色温)	3000K/4000K/6000K
Light efficiency(光效)	>80lm/W
Color rendering index(显色指数)	Ra≥80
Operating temperature(环境温度)	-25-+40
Rated life hours(工作寿命)	35,000-50,000H
LED Chip(芯片)	CREE  EPISTAR



+ (86) 186-8880-7020



Color(灯体外观颜色选择)



暖光白

LED driver (include)(LED驱动)

Output voltage(输出电压)	36-40V
Output current(输出电流)	800mA

AL-2 6

 **IMEXAO**
IMPORTERS EXPORTERS

"Let us help to build your dreams"



IMPORTERS

(86) 186-8880-7020

AL-2 7



"Let us help to build your dreams"



AL-2 8



"Let us help to build your dreams"

LED固定式灯具

020086

Luminaire Property (主要参数)

Light source(光源)	COB
Power(功率)	20W
Beam angle(光束角度)	24°
Color temperature(色温)	3000K/4000K/6000K
Light efficiency(光效)	>80lm/W
Color rendering index(显色指数)	Ra≥80
Operating temperature(环境温度)	-25 -+40
Rated life hours(工作寿命)	35,000-50,000H
LED Chip(芯片)	EPISTAR



Hangcai 恒彩



+ (86) 186-8880-7020



Color(灯体外观颜色选择)



黑色

暖光白

LED driver (include)(LED驱动)

Output voltage(输出电压)	36-40V
Output current(输出电流)	550mA

AL-2 9

 **IMEXAO**
IMPORTERS EXPORTERS

"Let us help to build your dreams"

LED固定式灯具

020087



Luminaire Property (主要参数)

Light source(光源)	COB
Power(功率)	30W
Beam angle(光束角度)	24°
Color temperature(色温)	3000K/4000K/6000K
Light efficiency(光效)	>80lm/W
Color rendering index(显色指数)	Ra≥80
Operating temperature(环境温度)	-25-+40
Rated life hours(工作寿命)	35,000-50,000H
LED Chip(芯片)	EPISTAR



+(86)-186-8880-7020



Color(灯体外观颜色选择)



黑色



哑光白

LED driver (include)(LED驱动)

Output voltage(输出电压)	36-40V
Output current(输出电流)	800mA

AL-2 10

 **IMEXAO**
IMPORTERS EXPORTERS

"Let us help to build your dreams"

LED固定式灯具

020082



Luminaire Property (主要参数)

Light source(光源)	COB
Power(功率)	30W
Beam angle(光束角度)	24°/60°
Color temperature(色温)	3000K/4000K/6000K
Light efficiency(光效)	>80lm/W
Color rendering index(显色指数)	Ra≥80
Operating temperature(环境温度)	-25~+40
Rated life hours(工作寿命)	35,000-50,000H
LED Chip(芯片)	EPISTAR



+ (86) 186-8880-7020



Color(灯体外观颜色选择)



黑色

暖光白

LED driver (include)(LED驱动)

Output voltage(输出电压)	36-40V
Output current(输出电流)	800mA

AL-2 11

 **IMEXAO**
IMPORTERS EXPORTERS

"Let us help to build your dreams"

LED固定式灯具

020083



Luminaire Property (主要参数)

Light source(光源)	COB
Power(功率)	12W
Beam angle(光束角度)	24°
Color temperature(色温)	3000K/4000K/6000K
Light efficiency(光效)	>80lm/W
Color rendering index(显色指数)	Ra≥80
Operating temperature(环境温度)	-25~+40
Rated life hours(工作寿命)	35,000-50,000H
LED Chip(芯片)	EPISTAR



+ (86) 186-8880-7020



Color(灯体外观颜色选择)

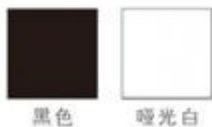

LED driver (include)(LED驱动)

Output voltage(输出电压)	36-40V
Output current(输出电流)	350mA

AL-2 12



"Let us help to build your dreams"

LED固定式灯具

020078



Luminaire Property (主要参数)

Light source(光源)	COB
Power(功率)	30W
Beam angle(光束角度)	15°/24°
Color temperature(色温)	3000K/4000K/6000K
Light efficiency(光效)	>80lm/W
Color rendering index(显色指数)	Ra≥80
Operating temperature(环境温度)	-25~+40
Rated life hours(工作寿命)	35,000-50,000H
LED Chip(芯片)	EPISTAR



+ (86) 186-8880-7020



Color(灯体外观颜色选择)

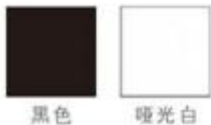

黑色 暖光白

LED driver (include)(LED驱动)

Output voltage(输出电压)	36-40V
Output current(输出电流)	800mA

AL-2 13

 **IMEXAO**
IMPORTERS EXPORTERS

"Let us help to build your dreams"

LED固定式灯具

020079



Luminaire Property (主要参数)

Light source(光源)	COB
Power(功率)	20W/30W
Beam angle(光束角度)	15°/24°
Color temperature(色温)	3000K/4000K/6000K
Light efficiency(光效)	>80lm/W
Color rendering index(显色指数)	Ra≥80
Operating temperature(环境温度)	-25--+40
Rated life hours(工作寿命)	35,000-50,000H
LED Chip(芯片)	EPistar



+ (86) 186-8880-7020



Color(灯体外观颜色选择)



黑色

哑光白

LED driver (include)(LED驱动)

Output voltage(输出电压)	36-40V
Output current(输出电流)	550mA(20W) 800mA(30W)

AL-2 14

 **IMEXAO**
IMPORTERS EXPORTERS

"Let us help to build your dreams"

LED固定式灯具

020071



Luminaire Property (主要参数)

Light source(光源)	COB
Power(功率)	20W
Beam angle(光束角度)	24°
Color temperature(色温)	3000K/4000K/6000K
Light efficiency(光效)	>80lm/W
Color rendering index(显色指数)	Ra≥80
Operating temperature(环境温度)	-25 -+40
Rated life hours(工作寿命)	35,000-50,000H
LED Chip(芯片)	EPISTAR



+ (86) 186-8880-7020



Color(灯体外观颜色选择)



黑色



暖光白

LED driver (include)(LED驱动)

Output voltage(输出电压)	36-40V
Output current(输出电流)	550mA

AL-2 15

 **IMEXAO**
IMPORTERS EXPORTERS

"Let us help to build your dreams"

LED固定式灯具

020072



Luminaire Property (主要参数)

Light source(光源)	COB
Power(功率)	30W
Beam angle(光束角度)	24°
Color temperature(色温)	3000K/4000K/6000K
Light efficiency(光效)	>80lm/W
Color rendering index(显色指数)	Ra≥80
Operating temperature(环境温度)	-25~+40
Rated life hours(工作寿命)	35,000-50,000H
LED Chip(芯片)	EPISTAR



+ (86) 186-8880-7020



Color(灯体外观颜色选择)

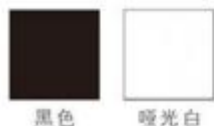

黑色

哑光白

LED driver (include)(LED驱动)

Output voltage(输出电压)	36-40V
Output current(输出电流)	800mA

AL-2 16

 **IMEXAO**
IMPORTERS EXPORTERS

"Let us help to build your dreams"

LED固定式灯具

020069



Luminaire Property (主要参数)

Light source(光源)	COB
Power(功率)	40W
Beam angle(光束角度)	24°
Color temperature(色温)	3000K/4000K/6000K
Light efficiency(光效)	>80lm/W
Color rendering index(显色指数)	Ra≥80
Operating temperature(环境温度)	-25~+40
Rated life hours(工作寿命)	35,000-50,000H
LED Chip(芯片)	CREE  EPISTAR



+ (86) 186-8880-7020



Color(灯体外观颜色选择)

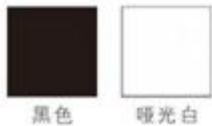

LED driver (include)(LED驱动)

Output voltage(输出电压)	39-43V
Output current(输出电流)	950mA

AL-2 17

LED固定式灯具

020070



Luminaire Property (主要参数)

Light source(光源)	COB
Power(功率)	12W
Beam angle(光束角度)	24°
Color temperature(色温)	3000K/4000K/6000K
Light efficiency(光效)	>80lm/W
Color rendering index(显色指数)	Ra≥80
Operating temperature(环境温度)	-25 -+40
Rated life hours(工作寿命)	35,000-50,000H
LED Chip(芯片)	EPISTAR



+ (86) 186-8880-7020



Color(灯体外观颜色选择)



黑色



暖光白

LED driver (include)(LED驱动)

Output voltage(输出电压)	36-40V
Output current(输出电流)	350mA

AL-2 18

 **IMEXAO**
IMPORTERS EXPORTERS

"Let us help to build your dreams"

LED固定式灯具

020067



Luminaire Property (主要参数)

Light source(光源)	COB
Power(功率)	35W
Beam angle(光束角度)	20°
Color temperature(色温)	3000K/4000K/6000K
Light efficiency(光效)	>80lm/W
Color rendering index(显色指数)	Ra≥80
Operating temperature(环境温度)	-25-+40
Rated life hours(工作寿命)	35,000-50,000H
LED Chip(芯片)	CREE  EPISTAR



+ (86) 186-8880-7020



Color(灯体外观颜色选择)



黑色

哑光白

LED driver (include)(LED驱动)

Output voltage(输出电压)	36-40V
Output current(输出电流)	800mA

AL-2 19

 **IMEXAO**
IMPORTERS EXPORTERS

"Let us help to build your dreams"

LED固定式灯具

020065



Luminaire Property (主要参数)

Light source(光源)	COB
Power(功率)	30W
Beam angle(光束角度)	15°/24°
Color temperature(色温)	3000K/4000K/6000K
Light efficiency(光效)	>80lm/W
Color rendering index(显色指数)	Ra≥80
Operating temperature(环境温度)	-25~+40
Rated life hours(工作寿命)	35,000-50,000H
LED Chip(芯片)	EPISTAR



+ (86) 186-8880-7020



Color(灯体外观颜色选择)



黑色



哑光白

LED driver (include)(LED驱动)

Output voltage(输出电压)	36-40V
Output current(输出电流)	800mA

AL-2 20



“Let us help to build your dreams”

LED固定式灯具

020061



Luminaire Property (主要参数)

Light source(光源)	COB
Power(功率)	7W
Beam angle(光束角度)	25°
Color temperature(色温)	3000K/4000K/6000K
Light efficiency(光效)	>80lm/W
Color rendering index(显色指数)	Ra≥80
Operating temperature(环境温度)	-25-+40
Rated life hours(工作寿命)	35,000-50,000H
LED Chip(芯片)	EPISTAR



+ (86) 186-8880-7020



Color(灯体外观颜色选择)



黑色

哑光白

LED driver (include)(LED驱动)

Output voltage(输出电压)	21-24V
Output current(输出电流)	350mA

AL-2 21

 **IMEXAO**
IMPORTERS EXPORTERS

"Let us help to build your dreams"

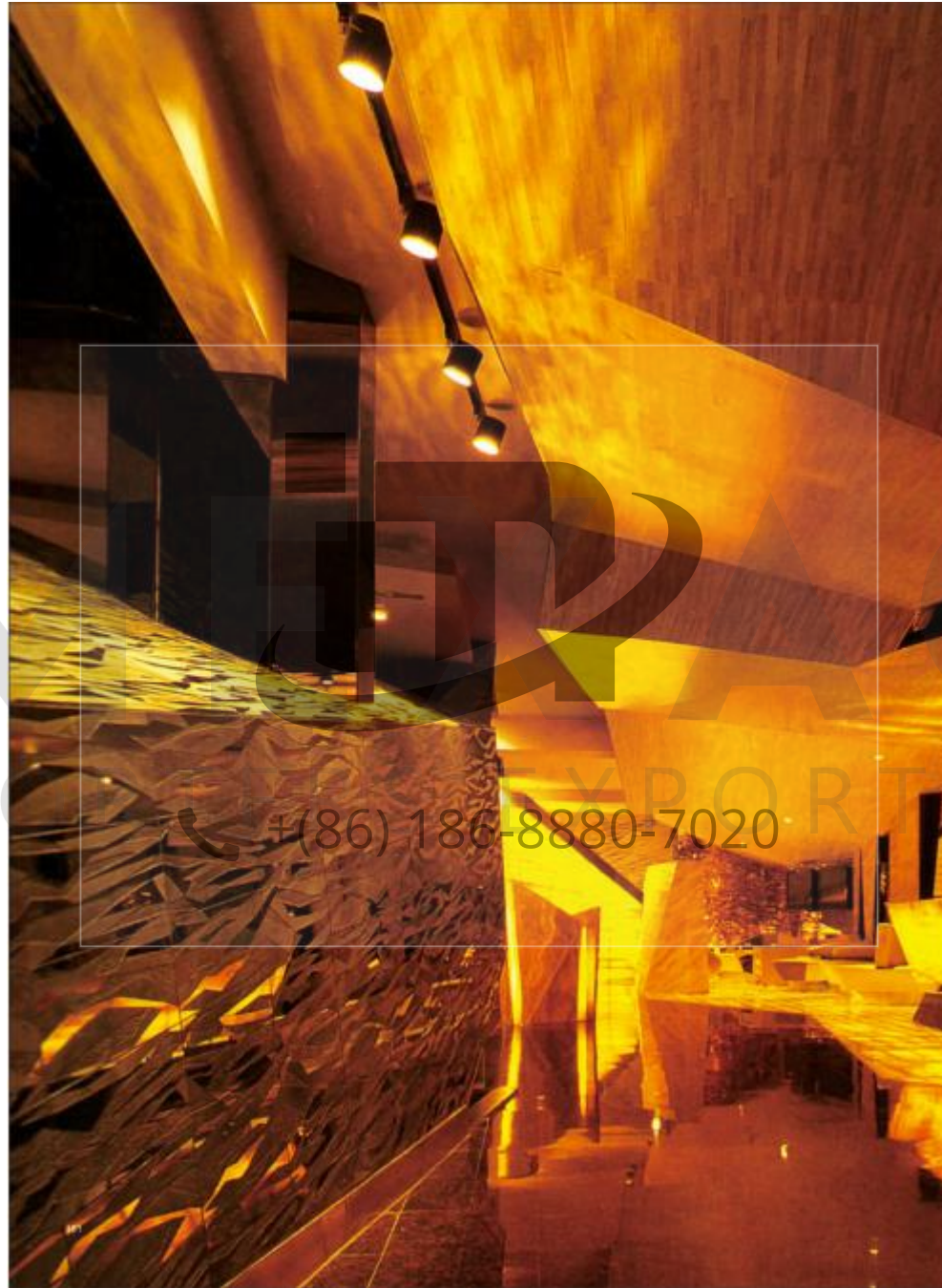

IMPORTERS EXPORTERS

+ (86) 186-8880-7020

AL-2 22

 **IMEXAO**
IMPORTERS EXPORTERS

"Let us help to build your dreams"

LED 固定式灯具

040225M



Luminaire Property (主要参数)

Light source(光源)	SMD
Power(功率)	18W
Beam angle(光束角度)	105°
Color temperature(色温)	3000K/4000K/6000K
Light efficiency(光效)	>80lm/W
Color rendering index(显色指数)	Ra≥80
Operating temperature(环境温度)	-25--+40
Rated life hours(工作寿命)	35,000-50,000H
LED Chip(芯片)	EPISTAR



+ (86) 186-8880-7020

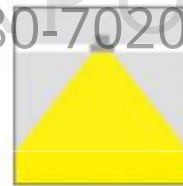

Color(灯体外观颜色选择)



暖光白

LED driver (include)(LED驱动)

Output voltage(输出电压)	45-72V
Output current(输出电流)	300mA

AL-2 23

 **IMEXAO**
IMPORTERS EXPORTERS

"Let us help to build your dreams"

Kangcai 康彩



LED 嵌入式灯具

040225S

Luminaire Property (主要参数)

Light source(光源)	SMD
Power(功率)	18W
Beam angle(光束角度)	105°
Color temperature(色温)	3000K/4000K/6000K
Light efficiency(光效)	>80lm/W
Color rendering index(显色指数)	Ra≥80
Operating temperature(环境温度)	-25 -+40
Rated life hours(工作寿命)	35,000-50,000H
LED Chip(芯片)	EPISTAR



+ (86) 186-8880-7020

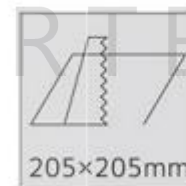

Color(灯体外观颜色选择)



哑光白

LED driver (include)(LED驱动)

Output voltage(输出电压)	45-72V
Output current(输出电流)	300mA

AL-2 24

 **IMEXAO**
IMPORTERS EXPORTERS

"Let us help to build your dreams"

Kangcai 康彩

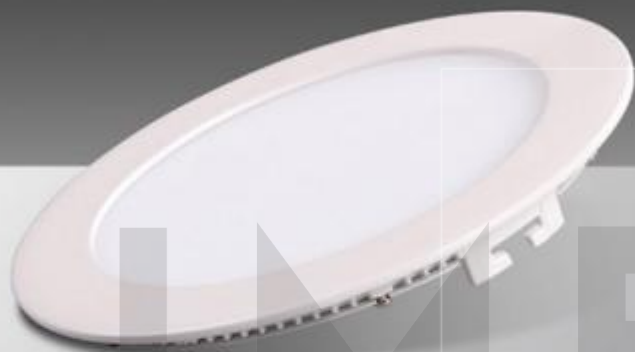

LED 嵌入式灯具

040225R

Luminaire Property (主要参数)

Light source(光源)	SMD
Power(功率)	18W
Beam angle(光束角度)	105°
Color temperature(色温)	3000K/4000K/6000K
Light efficiency(光效)	>80lm/W
Color rendering index(显色指数)	Ra≥80
Operating temperature(环境温度)	-25--+40
Rated life hours(工作寿命)	35,000-50,000H
LED Chip(芯片)	EPISTAR



+(86)-186-8880-7020

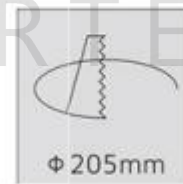

Color(灯体外观颜色选择)



暖光白

LED driver (include)(LED驱动)

Output voltage(输出电压)	45-72V
Output current(输出电流)	300mA

AL-2 25

 **IMEXAO**
IMPORTERS EXPORTERS

"Let us help to build your dreams"



IMPORTERS EXPORTERS

(86) 186-8880-7020

AL-2 26

 **IMEXAO**
IMPORTERS EXPORTERS

"Let us help to build your dreams"

Kangcai 康彩



LED 嵌入式灯具

030830-2

Luminaire Property (主要参数)

Light source(光源)	COB
Power(功率)	40W/50W
Beam angle(光束角度)	20°
Color temperature(色温)	3000K/4000K/6000K
Light efficiency(光效)	>80lm/W
Color rendering index(显色指数)	Ra≥80
Operating temperature(环境温度)	-25--+40
Rated life hours(工作寿命)	35,000-50,000H
LED Chip(芯片)	CREE  EPISTAR



+ (86) 186-8880-7020



Color(灯体外观颜色选择)

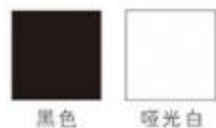

黑色

哑光白

LED driver (include)(LED驱动)

Output voltage(输出电压)	36-40V
Output current(输出电流)	550mA(20W) 700mA(25W)

AL-2 27

 **IMEXAO**
IMPORTERS EXPORTERS

"Let us help to build your dreams"

LED 嵌入式灯具

030829-3



Luminaire Property (主要参数)

Light source(光源)	COB
Power(功率)	45W
Beam angle(光束角度)	20°
Color temperature(色温)	3000K/4000K/6000K
Light efficiency(光效)	>80lm/W
Color rendering index(显色指数)	Ra≥80
Operating temperature(环境温度)	-25 -+40
Rated life hours(工作寿命)	35,000-50,000H
LED Chip(芯片)	CREE EPISTAR



+ (86) 186-8880-7020

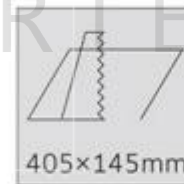

Color(灯体外观颜色选择)



黑色



哑光白

LED driver (include)(LED驱动)

Output voltage(输出电压)	30-33V
Output current(输出电流)	450mA

AL-2 28

IMEXAO
IMPORTERS EXPORTERS

"Let us help to build your dreams"

LED 嵌入式灯具

030829

Kangcai 康彩

Luminaire Property (主要参数)

Light source(光源)	COB
Power(功率)	15W
Beam angle(光束角度)	20°
Color temperature(色温)	3000K/4000K/6000K
Light efficiency(光效)	>80lm/W
Color rendering index(显色指数)	Ra≥80
Operating temperature(环境温度)	-25 -+40
Rated life hours(工作寿命)	35,000-50,000H

LED Chip(芯片)

CREE

EPISTAR



+(86) 186-8880-7020

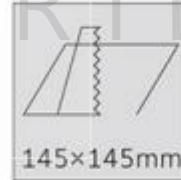

145×145mm

Color(灯体外观颜色选择)



黑色



哑光白

LED driver (include)(LED驱动)

Output voltage(输出电压) 30-33V

Output current(输出电流) 450mA

AL-2 29

 **IMEXAO**
IMPORTERS EXPORTERS

"Let us help to build your dreams"



AL-2 30



AL-2 31

LED 嵌入式灯具

010125



Luminaire Property (主要参数)

Light source(光源)	COB
Power(功率)	35W
Beam angle(光束角度)	50°
Color temperature(色温)	3000K/4000K/6000K
Light efficiency(光效)	>80lm/W
Color rendering index(显色指数)	Ra≥80
Operating temperature(环境温度)	-25-+40
Rated life hours(工作寿命)	35,000-50,000H
LED Chip(芯片)	CREE  EPISTAR



+ (86) 186-8880-7020



屏幕截图 Ctrl + Alt + A

Φ 150mm

截图时隐藏当前窗口

Color(灯体外观颜色选择)



暖光白

LED driver (include)(LED驱动)

Output voltage(输出电压)	36-40V
Output current(输出电流)	900mA

AL-2 32

 **IMEXAO**
IMPORTERS EXPORTERS

"Let us help to build your dreams"

Kangcai 康彩



LED 嵌入式灯具

010117

Luminaire Property (主要参数)

Light source(光源)	COB
Power(功率)	25W/30W
Beam angle(光束角度)	20°
Color temperature(色温)	3000K/4000K/6000K
Light efficiency(光效)	>80lm/W
Color rendering index(显色指数)	Ra≥80
Operating temperature(环境温度)	-25~+40
Rated life hours(工作寿命)	35,000-50,000H
LED Chip(芯片)	CREE  EPISTAR



+ (86) 186-8880-7020



Color(灯体外观颜色选择)



暖光白

LED driver (include)(LED驱动)

Output voltage(输出电压)	36-40V
Output current(输出电流)	550mA

AL-2 33

 **IMEXAO**
IMPORTERS EXPORTERS

"Let us help to build your dreams"

Kangcai 康彩



LED 嵌入式灯具

010059

Luminaire Property (主要参数)

Light source(光源)	COB
Power(功率)	10W
Beam angle(光束角度)	20°
Color temperature(色温)	3000K/4000K/6000K
Light efficiency(光效)	>80lm/W
Color rendering index(显色指数)	Ra≥80
Operating temperature(环境温度)	-25-+50
Rated life hours(工作寿命)	35,000-50,000H
LED Chip(芯片)	CREE  EPSTAR



+(86)-186-8880-7020

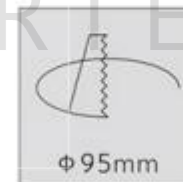

Color(灯体外观颜色选择)



拉丝银



拉丝金



拉丝黑

LED driver (include)(LED驱动)

Output voltage(输出电压)	30-33V
Output current(输出电流)	350mA

AL-2 34

 **IMEXAO**
IMPORTERS EXPORTERS

"Let us help to build your dreams"

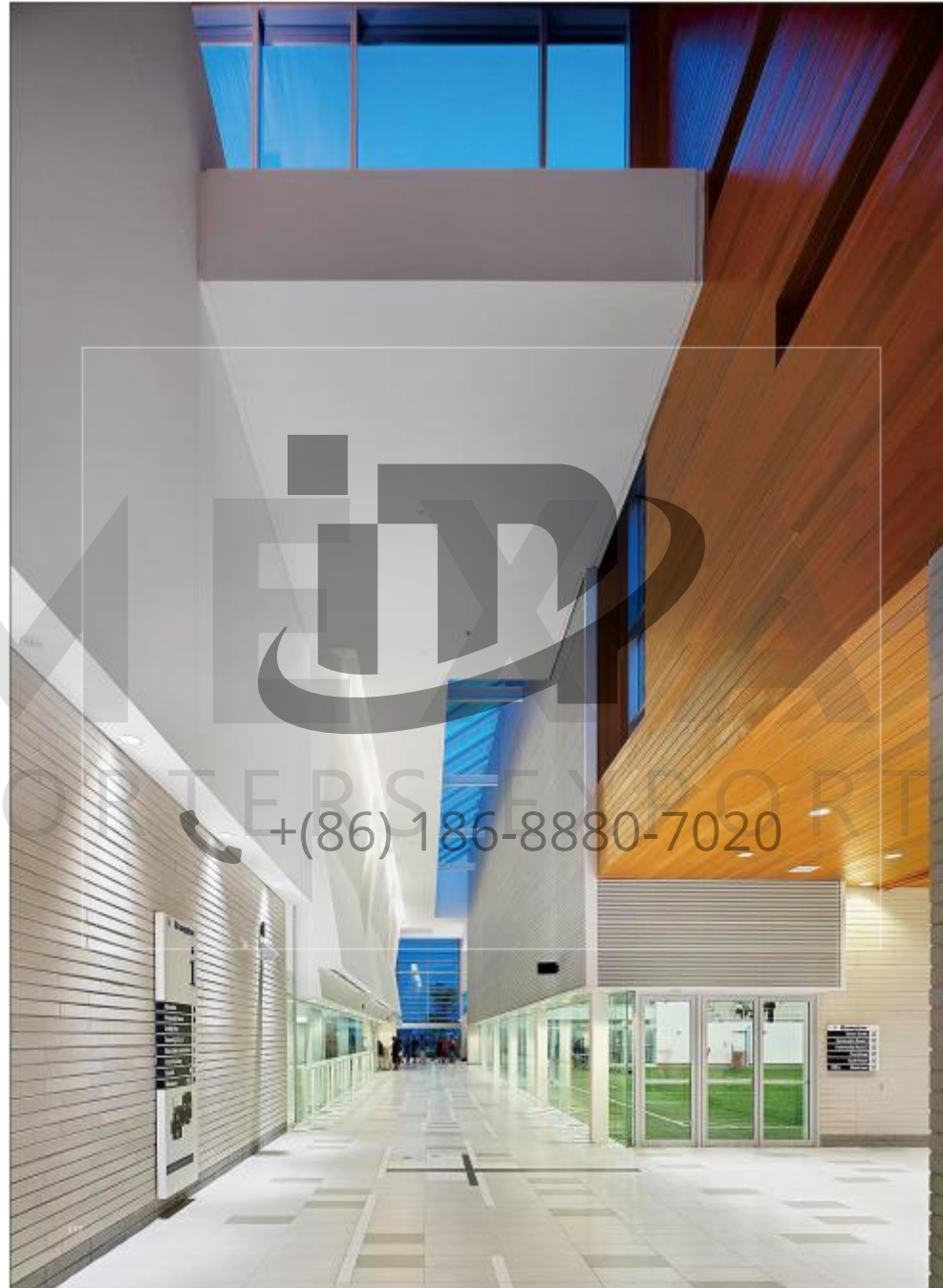

IMEXAO
IMPORTERS EXPORTERS
+ (86) 186-8880-7020

AL-2 35

 **IMEXAO**
IMPORTERS EXPORTERS

"Let us help to build your dreams"

LED 嵌入式灯具

010111B



Luminaire Property (主要参数)

Light source(光源)	SMD
Power(功率)	12W
Beam angle(光束角度)	25°
Color temperature(色温)	3000K/4000K/6000K
Light efficiency(光效)	>80lm/W
Color rendering index(显色指数)	Ra≥80
Operating temperature(环境温度)	-25-+40
Rated life hours(工作寿命)	35,000-50,000H
LED Chip(芯片)	EPISTAR



+ (86) 186-8880-7020

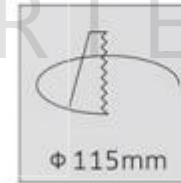

Color(灯体外观颜色选择)

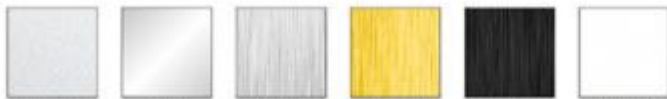

磨砂银 高光 拉丝银 拉丝金 拉丝黑 哑光白

LED driver (include)(LED驱动)

Output voltage(输出电压)	24-45V
Output current(输出电流)	350mA

AL-2 36

IMEXAO
IMPORTERS EXPORTERS

"Let us help to build your dreams"

Kangcai 康彩



LED 嵌入式灯具

010111

Luminaire Property (主要参数)

Light source(光源)	SMD
Power(功率)	3W/4W
Beam angle(光束角度)	25°
Color temperature(色温)	3000K/4000K/6000K
Light efficiency(光效)	>80lm/W
Color rendering index(显色指数)	Ra≥80
Operating temperature(环境温度)	-25~+40
Rated life hours(工作寿命)	35,000-50,000H
LED Chip(芯片)	EPISTAR



+(86) 186-8880-7020

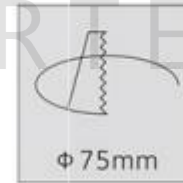

Color(灯体外观颜色选择)



磨砂银



高光



拉丝银



拉丝金



拉丝黑



哑光白

LED driver (include)(LED驱动)

Output voltage(输出电压)	9-12V
Output current(输出电流)	350mA

AL-2 37

IMEXAO
IMPORTERS EXPORTERS

"Let us help to build your dreams"



AL-2 38

LED 嵌入式灯具

010084F

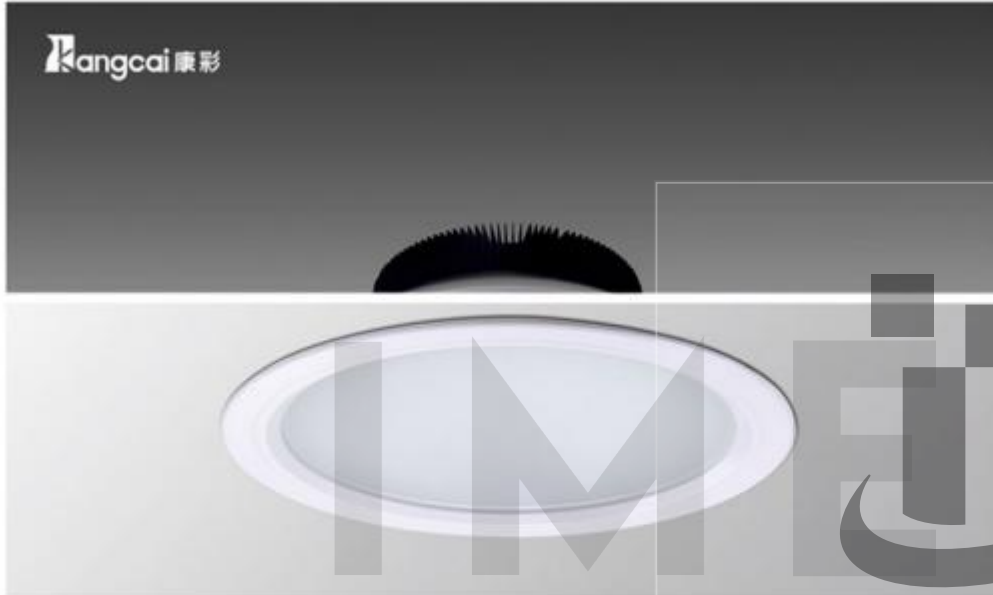

Luminaire Property (主要参数)

Light source(光源)	SMD
Power(功率)	18W/21W
Beam angle(光束角度)	110°
Color temperature(色温)	3000K/4000K/6000K
Light efficiency(光效)	>80lm/W
Color rendering index(显色指数)	Ra≥80
Operating temperature(环境温度)	-25--+50
Rated life hours(工作寿命)	35,000-50,000H
LED Chip(芯片)	EPISTAR



+ (86) 186-8880-7020

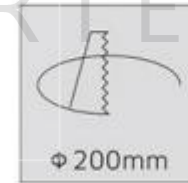

Color(灯体外观颜色选择)



磨砂银

哑光白

LED driver (include)(LED驱动)

Output voltage(输出电压)	36-68V(18W) 54-79V(21W)
Output current(输出电流)	350mA

AL-2 39

 **IMEXAO**
IMPORTERS EXPORTERS

"Let us help to build your dreams"



IMEXAO
IMPORTERS EXPORTERS
+ (86) 186-8880-7020

AL-2 40

LED 嵌入式灯具

010126



Luminaire Property (主要参数)

Light source(光源)	COB
Power(功率)	3W/5W
Beam angle(光束角度)	25°
Color temperature(色温)	3000K/4000K/6000K
Light efficiency(光效)	>80lm/W
Color rendering index(显色指数)	Ra≥80
Operating temperature(环境温度)	-25 -+40
Rated life hours(工作寿命)	35,000-50,000H
LED Chip(芯片)	EPistar



+ (86) 186-8880-7020

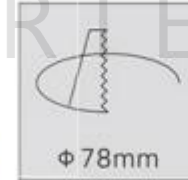

Color(灯体外观颜色选择)



暖光白

LED driver (include)(LED驱动)

Output voltage(输出电压)	9-11V
Output current(输出电流)	350mA

AL-2 41



"Let us help to build your dreams"

LED 嵌入式灯具

010129

Kangcai 康彩



Luminaire Property (主要参数)

Light source(光源)	COB
Power(功率)	8W
Beam angle(光束角度)	24°
Color temperature(色温)	3000K/4000K/6000K
Light efficiency(光效)	>80lm/W
Color rendering index(显色指数)	Ra≥80
Operating temperature(环境温度)	-25 -+40
Rated life hours(工作寿命)	35,000-50,000H
LED Chip(芯片)	CREE  EPISTAR



+ (86) 186-8880-7020

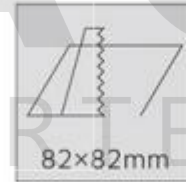

IMPORTERS EXPORTERS

Color(灯体外观颜色选择)



暖光白

LED driver (include)(LED驱动)

Output voltage(输出电压)	37V
Output current(输出电流)	200mA

AL-2 42

 **IMEXAO**
IMPORTERS EXPORTERS

"Let us help to build your dreams"



AL-3 1



AL-3 2



AL-3 3

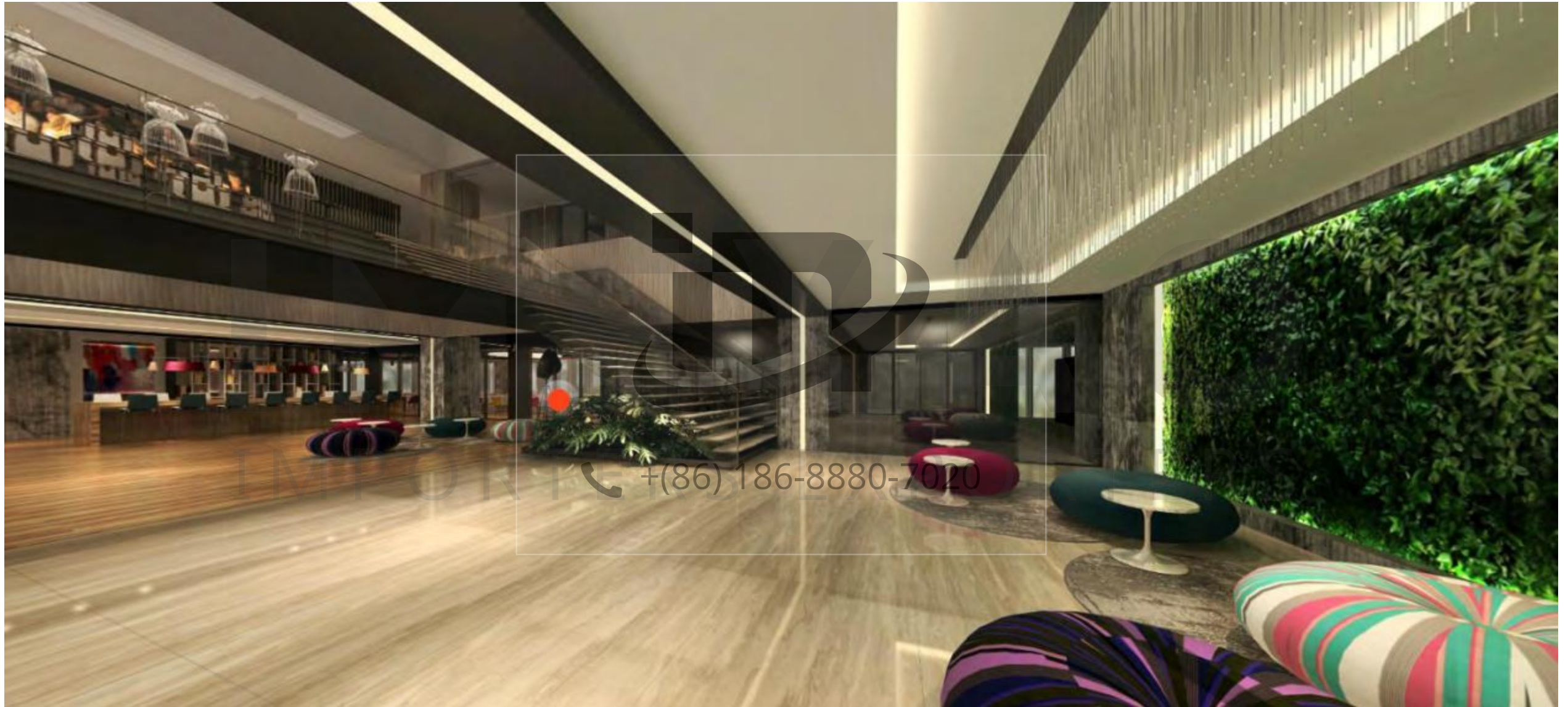

AL-3 4

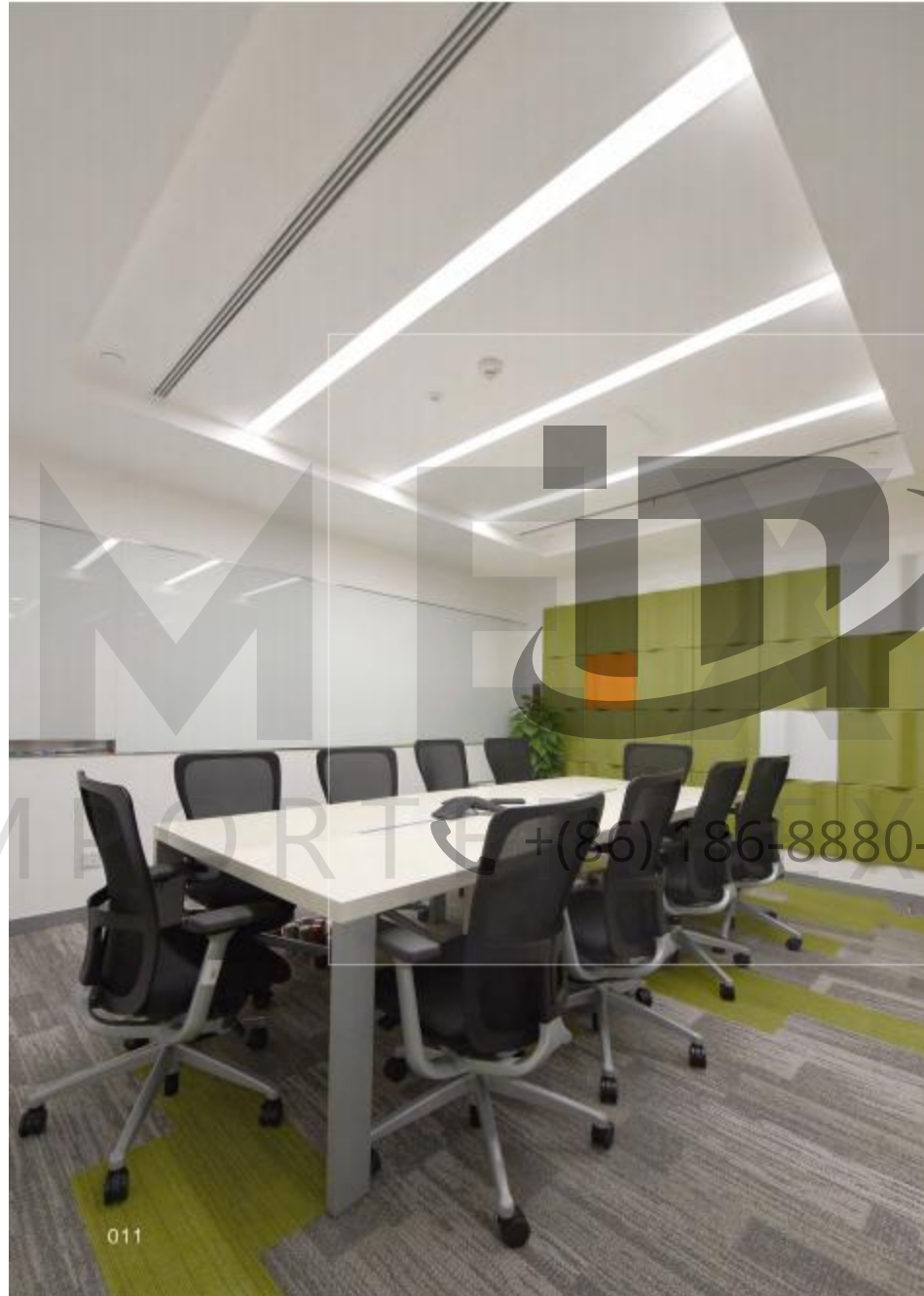

AL-3 5



AL-3 6



AL-3 7



AL-3 8



AL-3 9

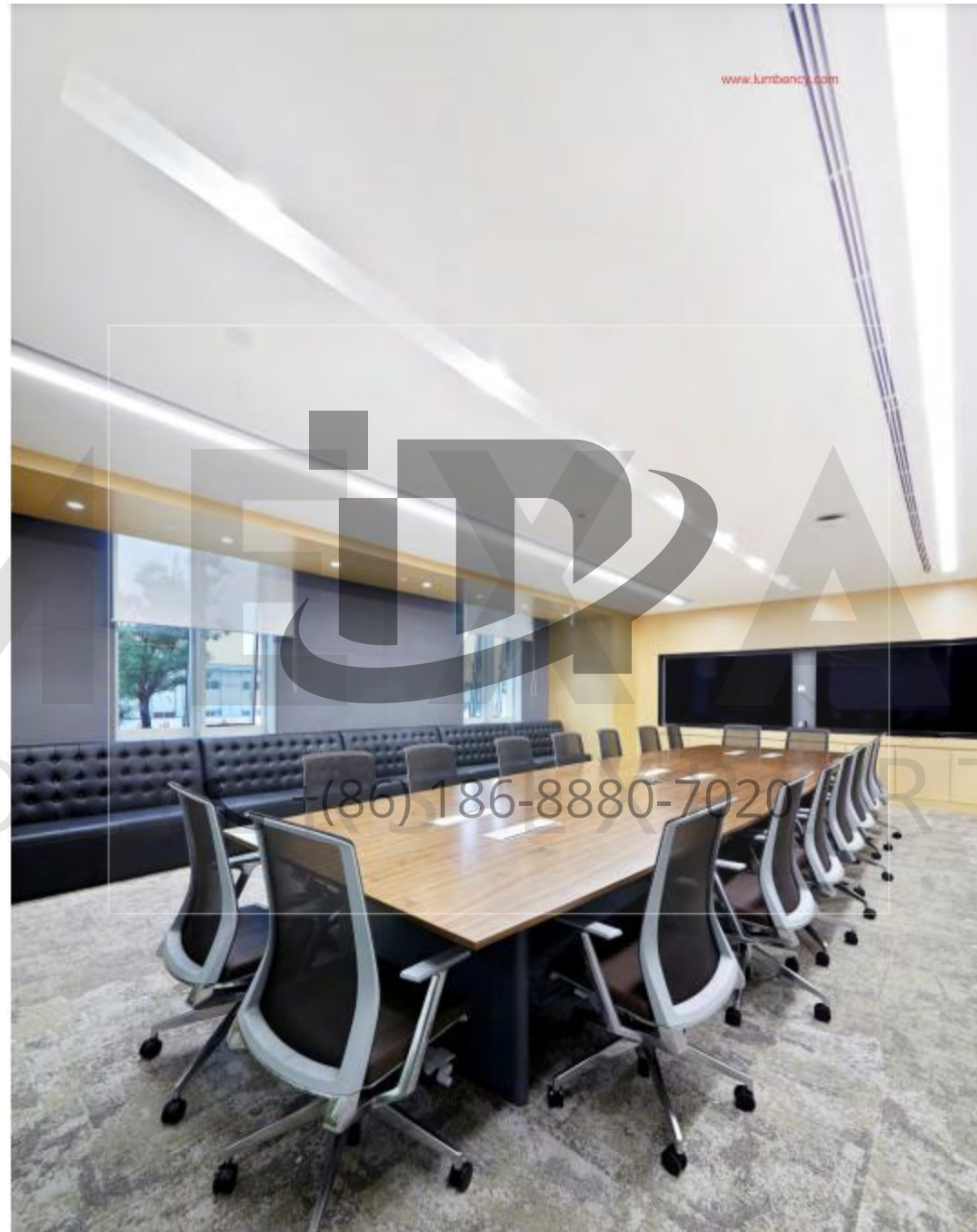

IMEXAO
IMPORTERS EXPORTERS
- (86) 186-8880-7020 -

AL-3 10



AL-3 11



AL-3 12



AL-3 13



AL-3 14

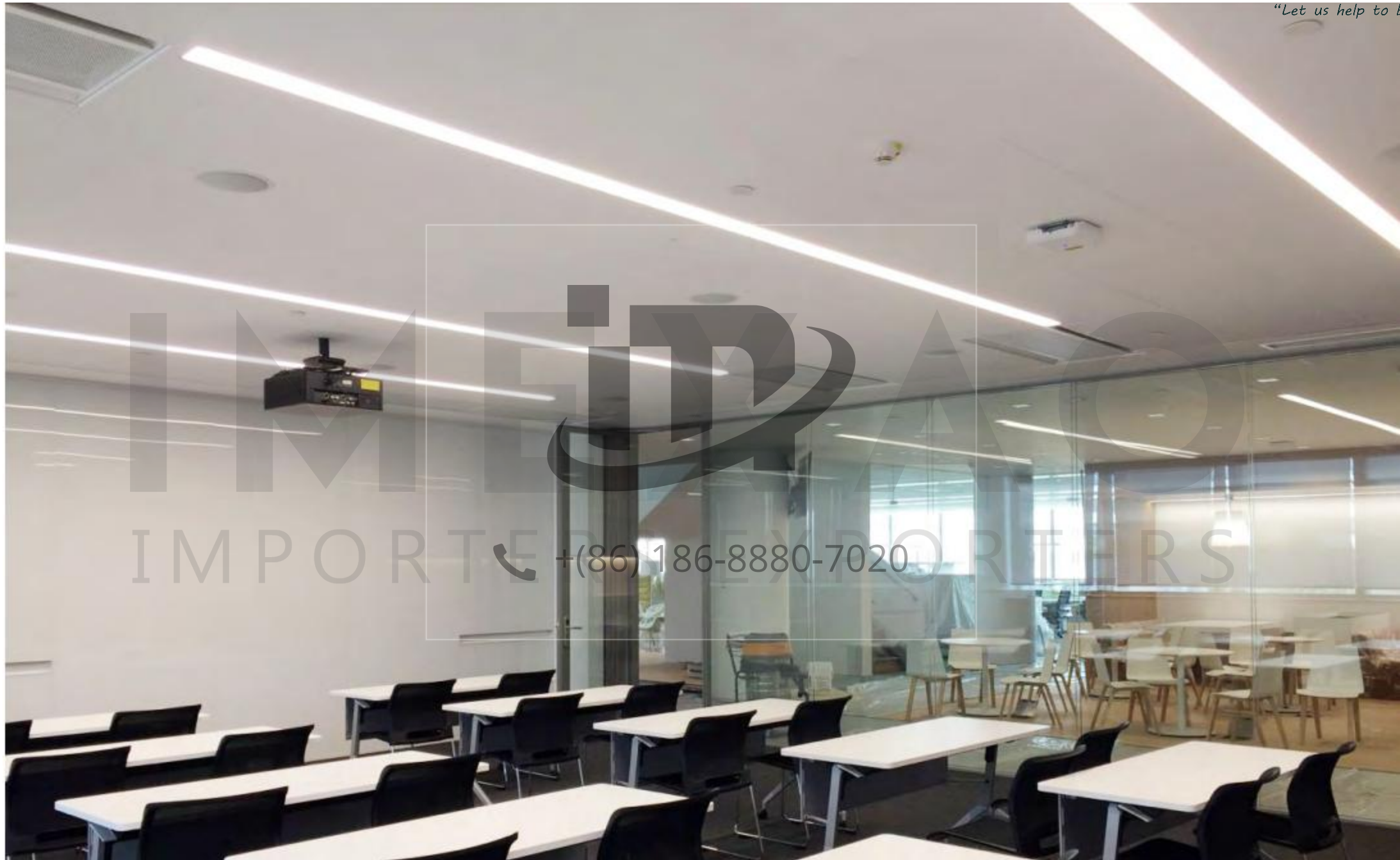

AL-3 15

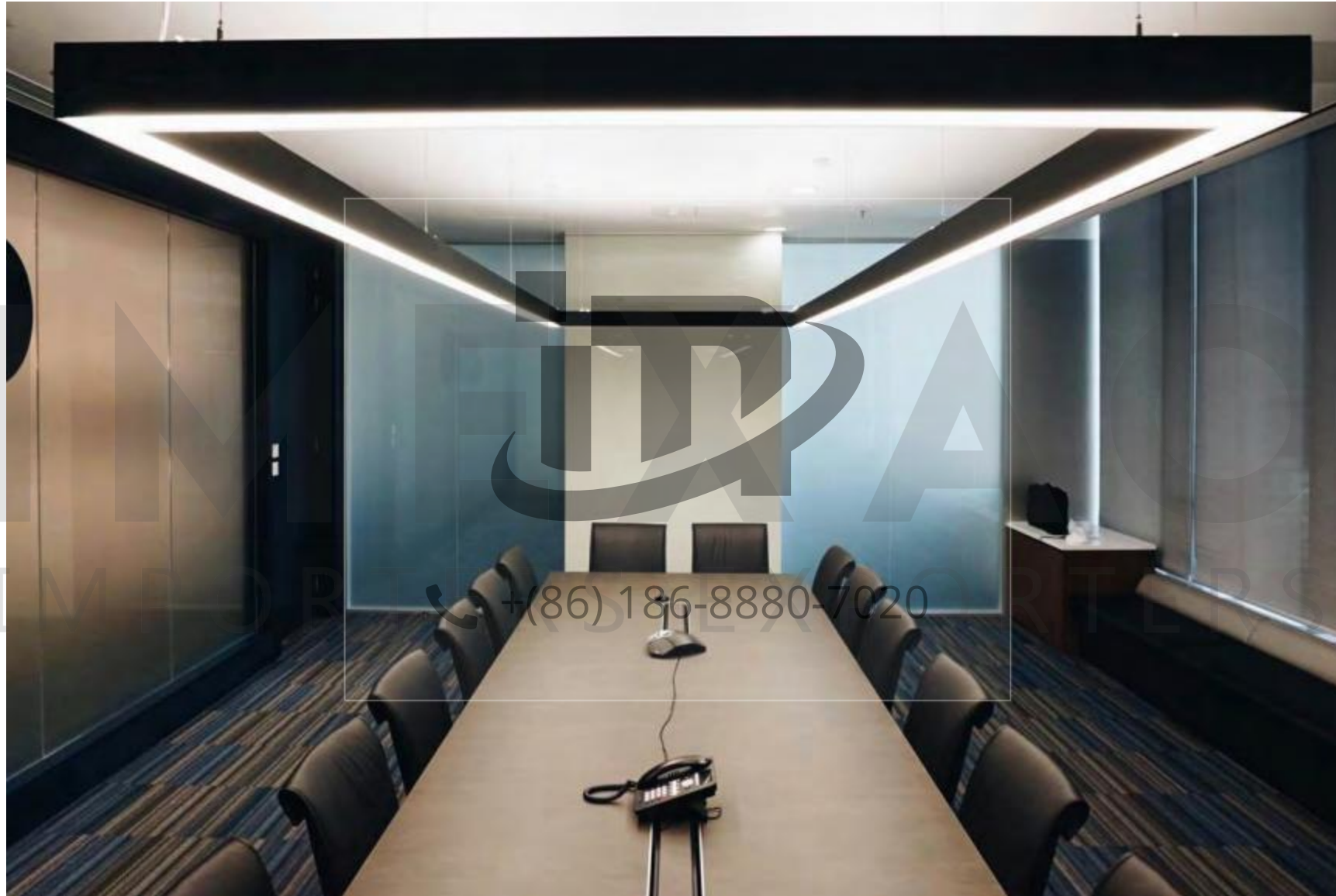

AL-3 16



AL-3 17



AL-3 18



+ (86) 186-8880-7020

AL-3 19

尚蒙

不仅是一个企业,更是一项事业

SUNMOON

我们不仅造灯 更是造光

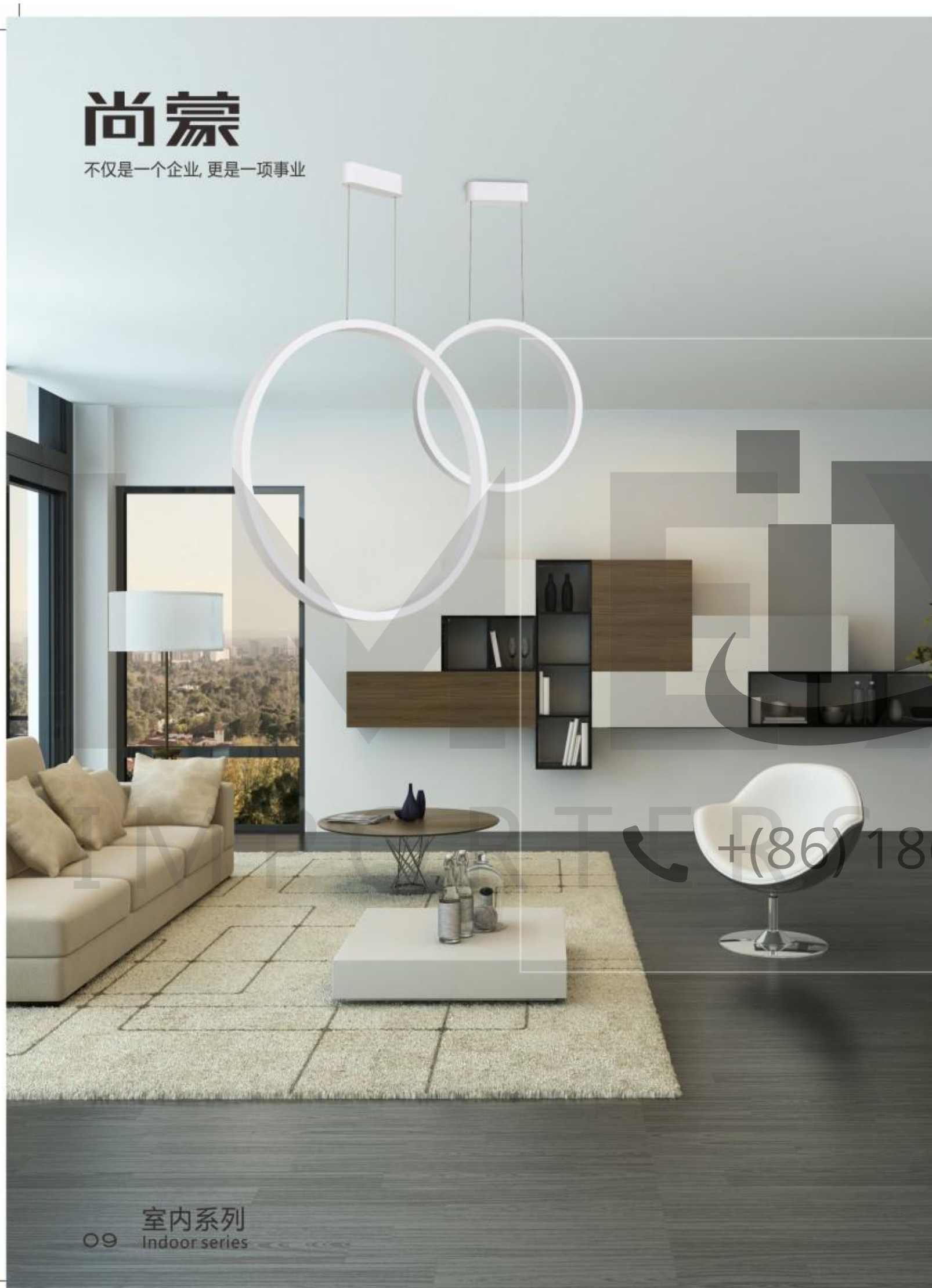

室内系列
Indoor series



MD1512-700

Input Current 输入电参数: AC 100-240V 50/60Hz
 Driver 驱动装置: DC 700mA 28-50V
 Power(Watts) 灯具功率: 27W
 Color Temperature 发光颜色/色温: 3000K/4000K/6000K
 IP level 防水等级: IP20
 Class 防触电保护等级: I II III
 Specification 外箱规格
 L 长: 77 cm
 W 宽: 13 cm
 H 高: 78 cm
 Qty/Ctn 数量: 1

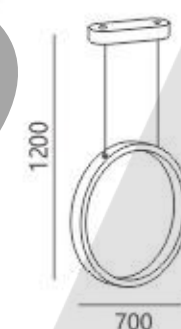

MD1512-430

Input Current 输入电参数: AC 100-240V 50/60Hz
 Driver 驱动装置: DC 700mA 28-50V
 Power(Watts) 灯具功率: 27W
 Color Temperature 发光颜色/色温: 3000K/4000K/6000K
 IP level 防水等级: IP20
 Class 防触电保护等级: I II III
 Specification 外箱规格
 L 长: 50 cm
 W 宽: 13 cm
 H 高: 51 cm
 Qty/Ctn 数量: 1



Body Color 灯体颜色



+ (86) 186-8880-7020

室内系列
Indoor series



23-24



25-26



27-28



47-48



49-50



51-52

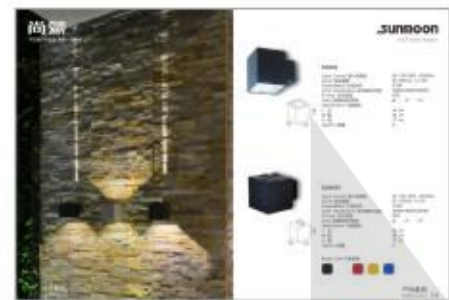

29-30

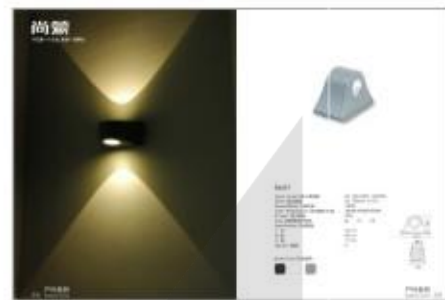

31-32

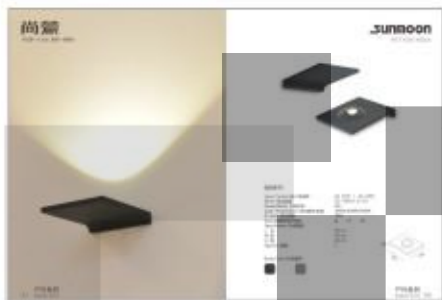

33-34



53-54



55-56

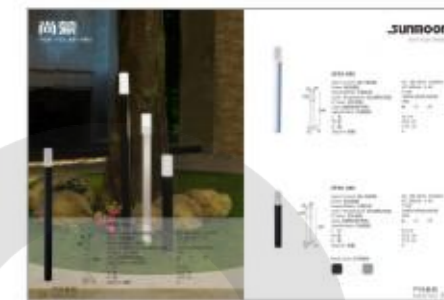

57-58



35-36



37-38

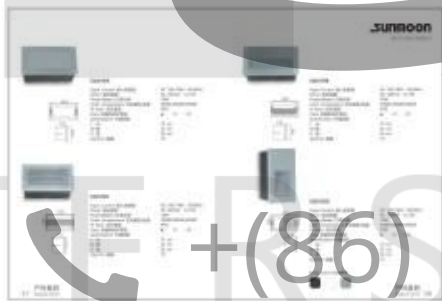

39-40



59-60



61-62



63-64



41-42



43-44



45-46



65-66



67-68

+ (86) 186-8880-7020

SUNMOON

我们不仅造灯 更是造光



IMEXAO IMPORTERS EXPORTERS

SQ36A

Input Current 输入电参数:	AC 100-240V 50/60Hz
Driver 驱动装置:	DC 350mA 2.8-12V
Power(Watts) 灯具功率:	4*1W
Color Temperature 发光颜色/色温:	3000K/4000K/6000K
IP level 防水等级:	IP65
Class 防触电保护等级:	■ I □ II □ III
Specification 外箱规格	
L 长:	22 cm
W 宽:	22 cm
H 高:	20 cm
Qty/Ctn 数量:	12

Body Color 灯体颜色

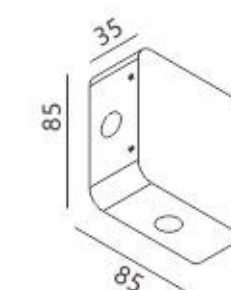

户外系列
Outdoor series

户外系列
Outdoor series 02

AL-5 B-01 (2)

尚慕

不仅是一个企业,更是一项事业

SUNMOON

我们不仅造灯 更是造光



室内系列
Indoor series

MD7048-570

Input Current 输入电参数: AC 220-240V 50/60Hz
Driver 驱动装置: DC 350mA 34-52V
Power(Watts) 灯具功率: 13W
Color Temperature 发光颜色/色温: 3000K/4000K/6000K
IP level 防水等级: IP20
Class 防触电保护等级: □ I ■ II □ III
Specification 外箱规格
L 长: 63 cm
W 宽: 63 cm
H 高: 22 cm
Qty/Ctn 数量: 1

Body Color 灯体颜色

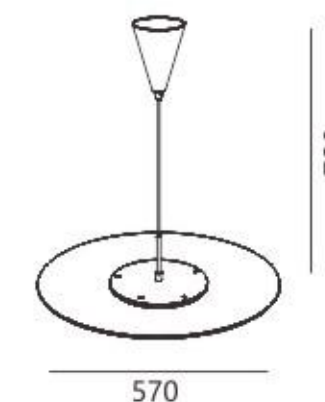

室内系列
Indoor series O2

AL-5 B-01

尚慕

不仅是一个企业,更是一项事业

SUNMOON

我们不仅造灯 更是造光



SQ37-1

Input Current 输入电参数:	AC 100-240V 50/60Hz
Driver 驱动装置:	DC 350mA 2.5-4V
Power(Watts) 灯具功率:	1W
Color Temperature 发光颜色/色温:	3000K/4000K/6000K
IP level 防水等级:	IP65
Class 防触电保护等级:	■ I □ II □ III
Specification 外箱规格	
L 长:	55 cm
W 宽:	29 cm
H 高:	19 cm
Qty/Ctn 数量:	20

SQ37-2

Input Current 输入电参数:	AC 100-240V 50/60Hz
Driver 驱动装置:	DC 350mA 2.8-12V
Power(Watts) 灯具功率:	2*1W
Color Temperature 发光颜色/色温:	3000K/4000K/6000K
IP level 防水等级:	IP65
Class 防触电保护等级:	■ I □ II □ III
Specification 外箱规格	
L 长:	55 cm
W 宽:	29 cm
H 高:	19 cm
Qty/Ctn 数量:	20

Body Color 灯体颜色

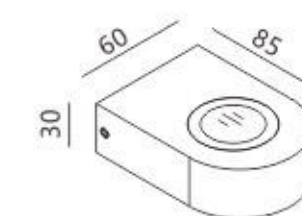

**用光塑造图案
用图案塑造氛围**
Shaping the pattern with light,
Create an atmosphere with a pattern

户外系列
O3 Outdoor series

户外系列
Outdoor series O4

AL-5 B-02 (2)

尚慕

不仅是一个企业, 更是一项事业



室内系列
Indoor series O3

SUNMOON

我们不仅造灯 更是造光

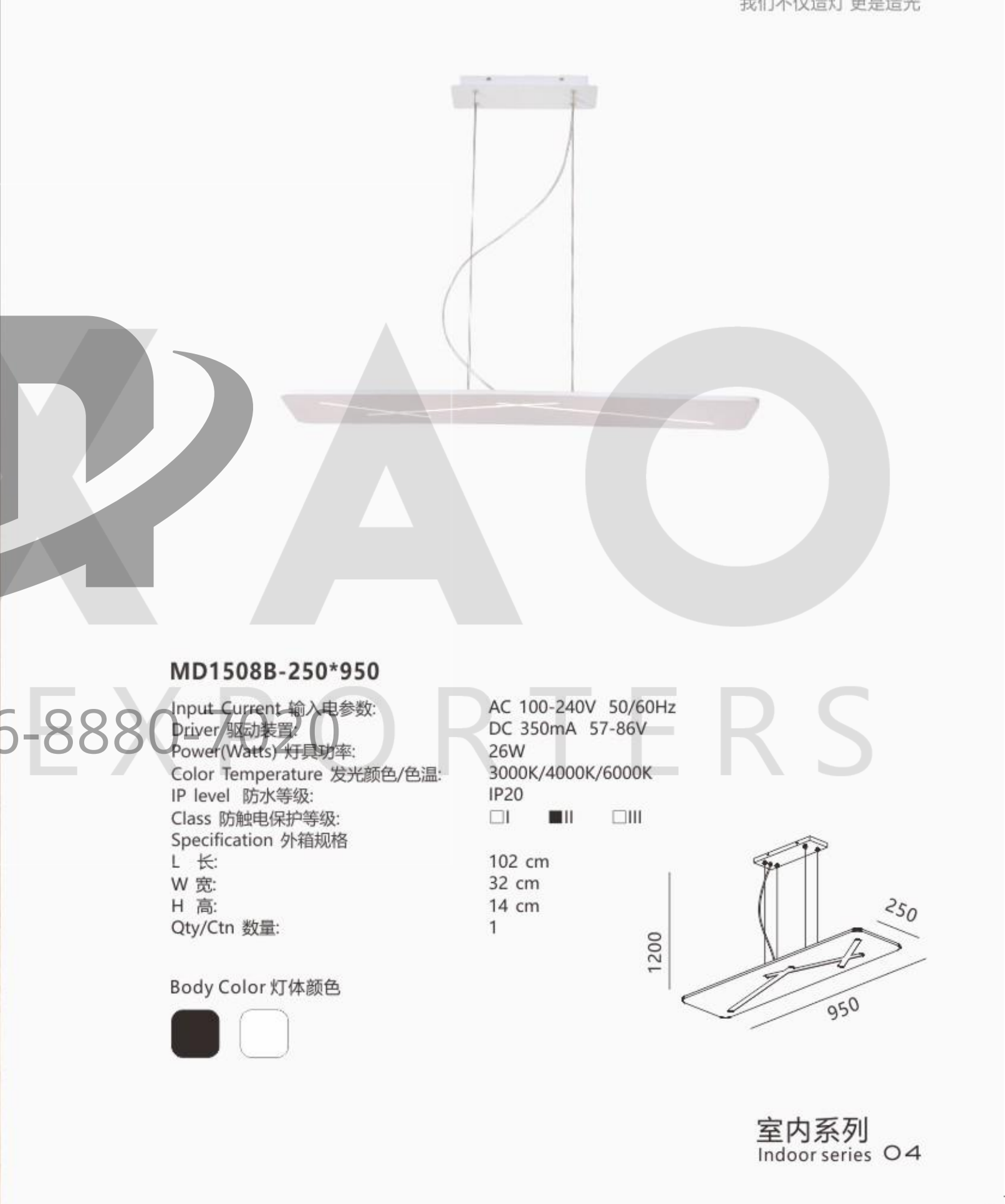

MD1508B-250*950

Input Current 输入电参数: AC 100-240V 50/60Hz
 Driver 驱动装置: DC 350mA 57-86V
 Power(Watts) 灯具功率: 26W
 Color Temperature 发光颜色/色温: 3000K/4000K/6000K
 IP level 防水等级: IP20
 Class 防触电保护等级: □I ■II □III
 Specification 外箱规格
 L 长: 102 cm
 W 宽: 32 cm
 H 高: 14 cm
 Qty/Ctn 数量: 1

Body Color 灯体颜色



室内系列
Indoor series O4

AL-5 B-02

尚蒙

不仅是一个企业,更是一项事业

SUNMOON

我们不仅造灯 更是造光



户外系列
O5 Outdoor series

SQ76

Input Current 输入电参数: AC 100-240V 50/60Hz
 Driver 驱动装置: DC 600mA 12-22V
 Power(Watts) 灯具功率: 2*5W
 Color Temperature 发光颜色/色温: 3000K/4000K/6000K
 IP level 防水等级: IP65
 Class 防触电保护等级: ■ I □ II □ III
 Specification 外箱规格
 L 长: 58 cm
 W 宽: 55 cm
 H 高: 28 cm
 Qty/Ctn 数量: 6

Body Color 灯体颜色



户外系列
Outdoor series O6

AL-5 B-03 (2)

尚慕

不仅是一个企业,更是一项事业

SUNMOON

我们不仅造灯 更是造光



MD8068-2

Input Current 输入电参数:
Driver 驱动装置:
Power(Watts) 灯具功率:
Color Temperature 发光颜色/色温:
IP level 防水等级:
Class 防触电保护等级:
Specification 外箱规格
L 长:
W 宽:
H 高:
Qty/Ctn 数量:

AC 100-240V 50/60Hz
DC 350mA 2.8-12V
1W
3000K/4000K/6000K
IP20
 I II III
105 cm
39 cm
21 cm
8



MD8068-1

Input Current 输入电参数:
Driver 驱动装置:
Power(Watts) 灯具功率:
Color Temperature 发光颜色/色温:
IP level 防水等级:
Class 防触电保护等级:
Specification 外箱规格
L 长:
W 宽:
H 高:
Qty/Ctn 数量:

AC 100-240V 50/60Hz
DC 350mA 2.8-12V
1W
3000K/4000K/6000K
IP20
 I II III
105 cm
39 cm
21 cm
8

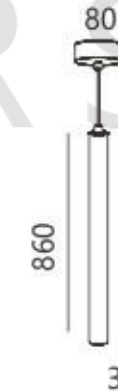

Body Color 灯体颜色



MD8068-3

Input Current 输入电参数:
Driver 驱动装置:
Power(Watts) 灯具功率:
Color Temperature 发光颜色/色温:
IP level 防水等级:
Class 防触电保护等级:
Specification 外箱规格
L 长:
W 宽:
H 高:
Qty/Ctn 数量:

AC 100-240V 50/60Hz
DC 350mA 2.8-12V
1W
3000K/4000K/6000K
IP20
 I II III
105 cm
39 cm
21 cm
8

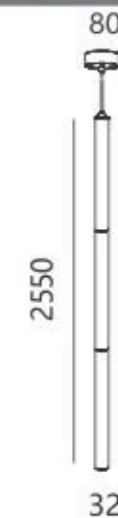

O5 室内系列
Indoor series

室内系列 O6
Indoor series

AL-5 B-03

尚慕

不仅是一个企业, 更是一项事业

SUNMOON

我们不仅造灯 更是造光

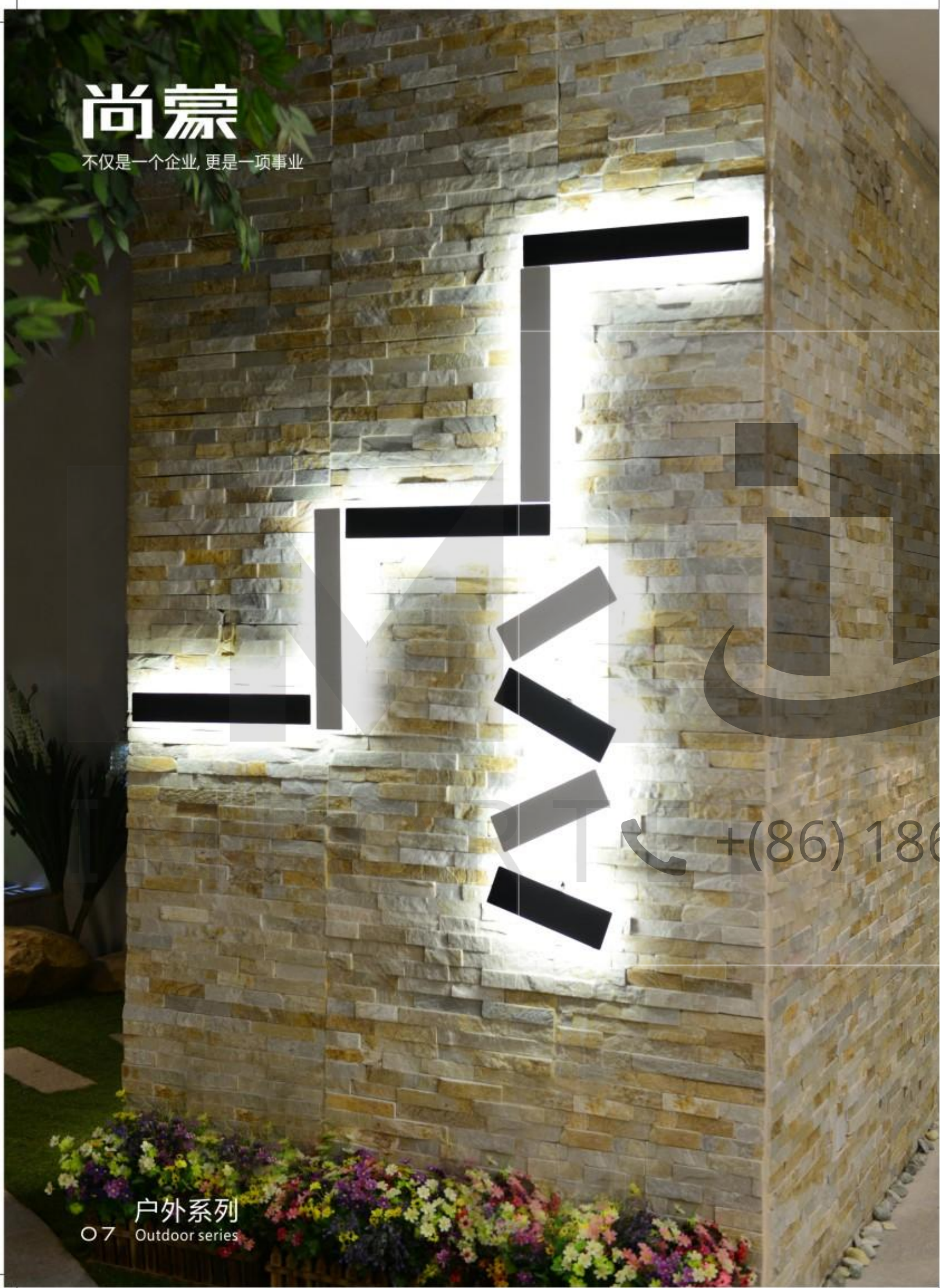

户外系列
O7 Outdoor series

户外系列
Outdoor series O8

SQ557

Input Current 输入电参数: AC 100-240V 50/60Hz
 Driver 驱动装置: DC 350mA 48V(Max)
 Power(Watts) 灯具功率: 16W
 Color Temperature 发光颜色/色温: 3000K/4000K/6000K
 IP level 防水等级: IP65
 Class 防触电保护等级: I II III
 Specification 外箱规格
 L 长: 55 cm
 W 宽: 33 cm
 H 高: 18 cm
 Qty/Ctn 数量: 10



SQ299

Input Current 输入电参数: AC 100-240V 50/60Hz
 Driver 驱动装置: DC 350mA 9-36V
 Power(Watts) 灯具功率: 8W
 Color Temperature 发光颜色/色温: 3000K/4000K/6000K
 IP level 防水等级: IP65
 Class 防触电保护等级: I II III
 Specification 外箱规格
 L 长: 52 cm
 W 宽: 31 cm
 H 高: 14 cm
 Qty/Ctn 数量: 10



Body Color 灯体颜色



+ (86) 186-8880-7020

AL-5 B-04 (2)

尚慕

不仅是一个企业, 更是一项事业



○7 室内系列
Indoor series

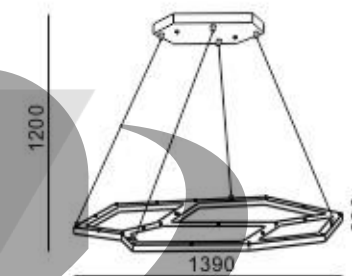

MD9010

Input Current 输入电参数:	AC 100-240V 50/60Hz
Driver 驱动装置:	DC 350mA 60-100V(4PCS)
Power(Watts) 灯具功率:	140W
Color Temperature 发光颜色/色温:	3000K/6000K
IP level 防水等级:	IP20
Class 防触电保护等级:	<input type="checkbox"/> I <input checked="" type="checkbox"/> II <input type="checkbox"/> III
Specification 外箱规格	
L 长:	146 cm
W 宽:	76 cm
H 高:	10 cm
Qty/Ctn 数量:	1

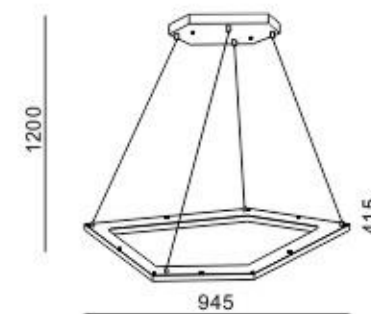

MD9011

Input Current 输入电参数:	AC 100-240V 50/60Hz
Driver 驱动装置:	DC 350mA 45-74.3V(2PCS)
Power(Watts) 灯具功率:	40W
Color Temperature 发光颜色/色温:	3000K/6000K
IP level 防水等级:	IP20
Class 防触电保护等级:	<input type="checkbox"/> I <input checked="" type="checkbox"/> II <input type="checkbox"/> III
Specification 外箱规格	
L 长:	98 cm
W 宽:	46 cm
H 高:	10 cm
Qty/Ctn 数量:	1

+ (86) 186-8880-7020

室内系列
Indoor series ○8

尚慕

不仅是一个企业,更是一项事业

友谊之光
Friendship Light

明与暗的交织,黑与白的相容,外型是相握的手,导光板的柔美之光,与黑色金属相衬相容。外观简洁而有张力。

Interwoven light and dark, black and white compatibility, appearance is hands held hands, soft light guide plate, and black metal contrast compatibility. Looks simple but there is tension.

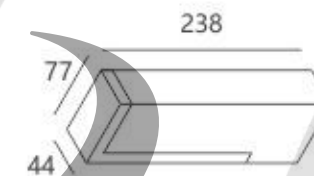

SQ34

Input Current 输入电参数:
Driver 驱动装置:
Power(Watts) 灯具功率:
Color Temperature 发光颜色/色温:
IP level 防水等级:
Class 防触电保护等级:
Specification 外箱规格
L 长:
W 宽:
H 高:
Qty/Ctn 数量:

AC 100-240V 50/60Hz
DC 300mA 12-25V
2*2W
3000K/4000K/6000K
IP65
■ I □ II □ III
47 cm
26 cm
16 cm
10

+ (86) 186-8880-7020

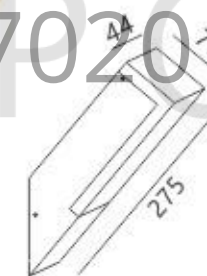

SQ35

Input Current 输入电参数:
Driver 驱动装置:
Power(Watts) 灯具功率:
Color Temperature 发光颜色/色温:
IP level 防水等级:
Class 防触电保护等级:
Specification 外箱规格
L 长:
W 宽:
H 高:
Qty/Ctn 数量:

AC 100-240V 50/60Hz
DC 300mA 12-25V
2*2W
3000K/4000K/6000K
IP65
■ I □ II □ III
47 cm
30 cm
16 cm
10

Body Color 灯体颜色



光随我动
Light with mind

户外系列
Outdoor series

户外系列
Outdoor series

AL-5 B-05 (2)

尚慕

不仅是一个企业, 更是一项事业

SUNMOON

我们不仅造灯 更是造光



+ (86) 186-8880-7020

SQ225

Input Current 输入电参数:	AC 100-240V 50/60Hz
Driver 驱动装置:	DC 700mA 3-10.5V
Power(Watts) 灯具功率:	2*3W
Color Temperature 发光颜色/色温:	3000K/4000K/6000K
IP level 防水等级:	IP65
Class 防触电保护等级:	■ I □ II □ III
Specification 外箱规格	
L 长:	52 cm
W 宽:	18.5 cm
H 高:	22 cm
Qty/Ctn 数量:	10

Body color 灯体颜色

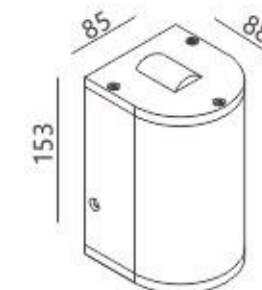

户外系列

Outdoor series

户外系列

Outdoor series | 2

AL-5 B-06 (2)

尚蒙

不仅是一个企业,更是一项事业

SUNMOON

我们不仅造灯 更是造光



INDOOR

(86) 186-8880-7020



MC1512-700

Input Current 输入电参数:	AC 100-240V 50/60Hz
Driver 驱动装置:	DC 700mA 28-50V
Power(Watts) 灯具功率:	27W
Color Temperature 发光颜色/色温:	3000K/4000K/6000K
IP level 防水等级:	IP20
Class 防触电保护等级:	<input type="checkbox"/> I <input checked="" type="checkbox"/> II <input type="checkbox"/> III
Specification 外箱规格	
L 长:	77 cm
W 宽:	13 cm
H 高:	82 cm
Qty/Ctn 数量:	1



MC1512-430

Input Current 输入电参数:	AC 100-240V 50/60Hz
Driver 驱动装置:	DC 700mA 28-50V
Power(Watts) 灯具功率:	27W
Color Temperature 发光颜色/色温:	3000K/4000K/6000K
IP level 防水等级:	IP20
Class 防触电保护等级:	<input type="checkbox"/> I <input checked="" type="checkbox"/> II <input type="checkbox"/> III
Specification 外箱规格	
L 长:	50 cm
W 宽:	13 cm
H 高:	54 cm
Qty/Ctn 数量:	1



Body Color 灯体颜色



室内系列
Indoor series

室内系列
Indoor series | 2

AL-5 B-06

尚慕

不仅是一个企业, 更是一项事业

SUNMOON

我们不仅造灯 更是造光



室内系列
Indoor series

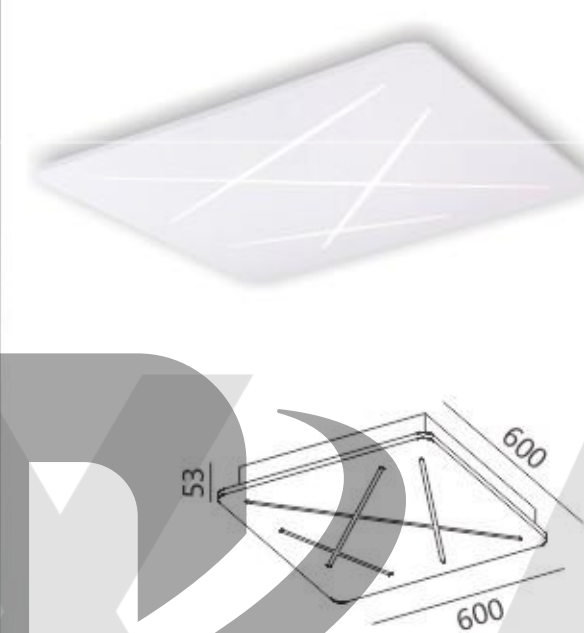

MC1508B-600

Input Current 输入电参数:	AC 100-240V 50/60Hz
Driver 驱动装置:	DC 700mA 47-71.5V
Power(Watts) 灯具功率:	45W
Color Temperature 发光颜色/色温:	3000K/4000K/6000K
IP level 防水等级:	IP20
Class 防触电保护等级:	<input type="checkbox"/> I <input checked="" type="checkbox"/> II <input type="checkbox"/> III
Specification 外箱规格	
L 长:	66 cm
W 宽:	66 cm
H 高:	12 cm
Qty/Ctn 数量:	1

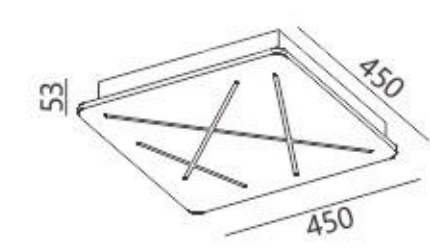

MC1508B-450

Input Current 输入电参数:	AC 100-240V 50/60Hz
Driver 驱动装置:	DC 700mA 57V
Power(Watts) 灯具功率:	33W
Color Temperature 发光颜色/色温:	3000K/4000K/6000K
IP level 防水等级:	IP20
Class 防触电保护等级:	<input type="checkbox"/> I <input checked="" type="checkbox"/> II <input type="checkbox"/> III
Specification 外箱规格	
L 长:	51 cm
W 宽:	51 cm
H 高:	12 cm
Qty/Ctn 数量:	1

Body Color 灯体颜色



+ (86) 186-8880-7020

室内系列
Indoor series

AL-5 B-07

尚蒙

不仅是一个企业,更是一项事业

SUNMOON

我们不仅造灯 更是造光

IMEXAO IMPORTERS EXPORTERS

+ (86) 186-8880-7020

MB2032

Input Current 输入电参数:	AC 100-240V 50/60Hz
Driver 驱动装置:	DC 350mA 2.8-12V
Power(Watts) 灯具功率:	2*1W
Color Temperature 发光颜色/色温:	3000K/4000K/6000K
IP level 防水等级:	IP20
Class 防触电保护等级:	<input type="checkbox"/> I <input type="checkbox"/> II <input checked="" type="checkbox"/> III
Specification 外箱规格	
L 长:	66 cm
W 宽:	20 cm
H 高:	14 cm
Qty/Ctn 数量:	5

Body Color 灯体颜色

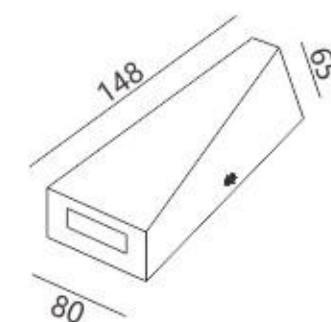

室内系列
Indoor series | 7

室内系列
Indoor series | 8

AL-5 B-09

尚慕

不仅是一个企业,更是一项事业

SUNMOON

我们不仅造灯 更是造光

MB1508B

Input Current 输入电参数:

AC 220-240V 50/60Hz

Driver 驱动装置:

DC 300mA 12-18V

Power(Watts) 灯具功率:

5W

Color Temperature 发光颜色/色温:

3000K/4000K/6000K

IP level 防水等级:

IP20

Class 防触电保护等级:

I II III

Specification 外箱规格

L 长:

40 cm

W 宽:

18 cm

H 高:

10 cm

Qty/Ctn 数量:

1

Body Color 灯体颜色

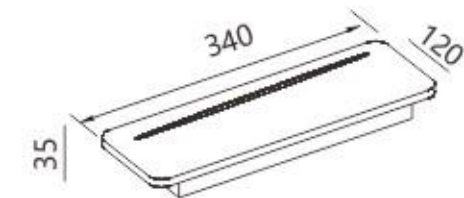

室内系列
Indoor series

室内系列
Indoor series 20

AL-5 B-10

尚蒙

不仅是一个企业,更是一项事业

SUNMOON

我们不仅造灯 更是造光

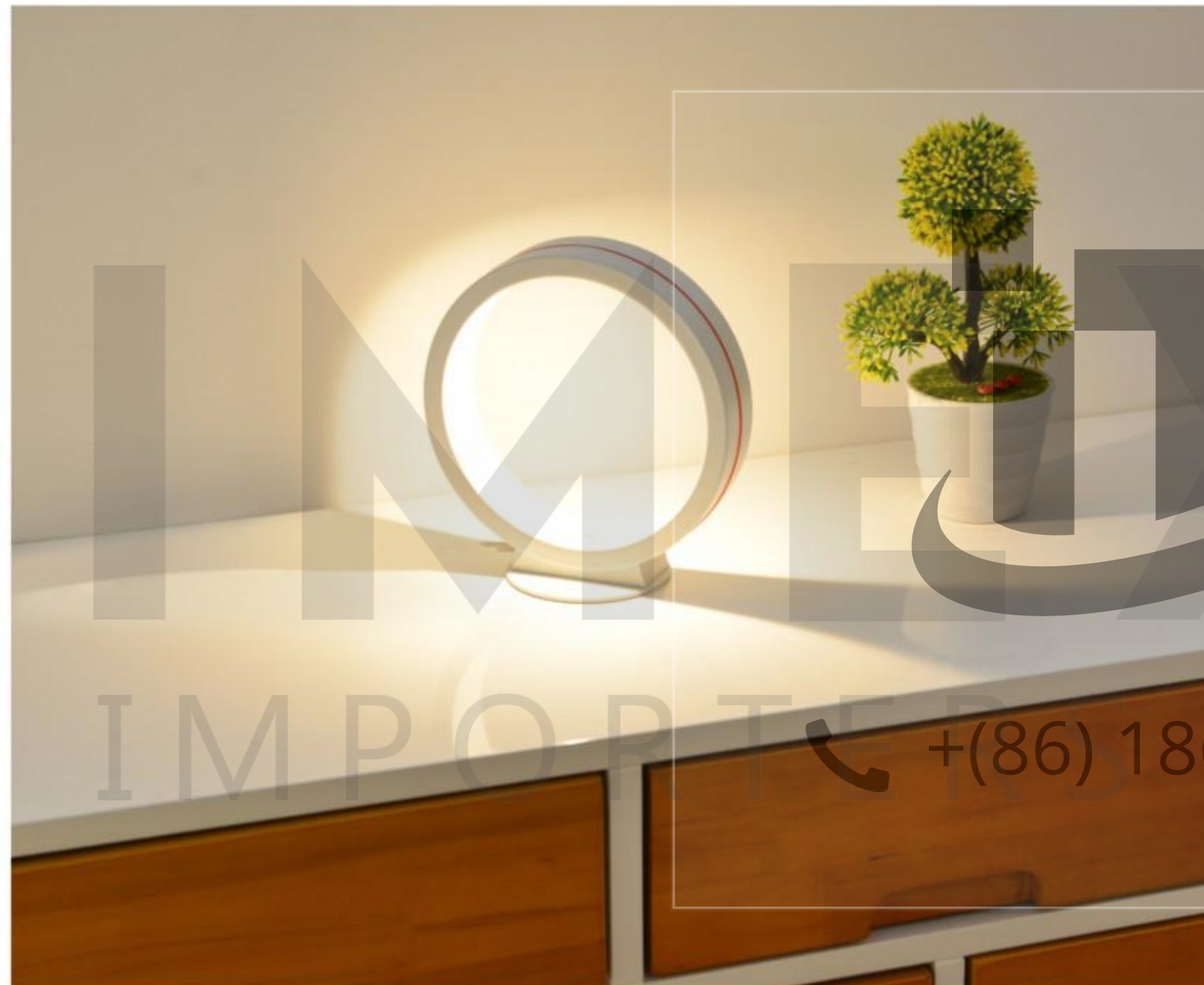

MT1512

Input Current 输入电参数:	AC 100-240V 50/60Hz
Driver 驱动装置:	DC 700mA 2.8-7V
Power(Watts) 灯具功率:	4-7W
Color Temperature 发光颜色/色温:	3000K/4000K/6000K
IP level 防水等级:	IP20
Class 防触电保护等级:	<input type="checkbox"/> I <input checked="" type="checkbox"/> II <input type="checkbox"/> III
Specification 外箱规格	
L 长:	54 cm
W 宽:	54 cm
H 高:	31 cm
Qty/Ctn 数量:	8

Body Color 灯体颜色

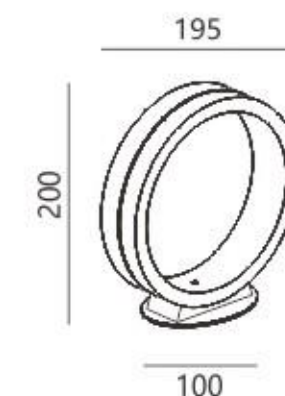

2 | 室内系列
Indoor series

室内系列 2 2
Indoor series

AL-5 B-11

尚蒙

不仅是一个企业,更是一项事业

光线开闭 随手而动
Light with waved

SUNMOON

我们不仅造灯 更是造光



光 随我动
Light with mind

只需挥挥手,
电源可随手开启与关闭,
还有4档明暗控制,自由转换氛围。

Light opening and closing,
moving with waved,
power can be readily opened and closed,
there are four files brightness control,
can convert atmosphere freely.

23 室内系列
Indoor series

+ (86) 186-8880-7020

MT7048C

Input Current 输入电参数:	AC 220-240V 50/60Hz
Driver 驱动装置:	DC 350mA 10-20V
Power(Watts) 灯具功率:	2-4-6W
Color Temperature 发光颜色/色温:	3000K/4000K/6000K
IP level 防水等级:	IP20
Class 防触电保护等级:	<input type="checkbox"/> I <input checked="" type="checkbox"/> II <input type="checkbox"/> III
Specification 外箱规格	
L 长:	36 cm
W 宽:	36 cm
H 高:	47 cm
Qty/Ctn 数量:	1

Body Color 灯体颜色

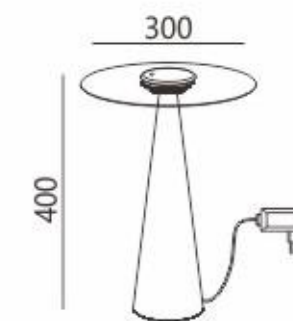

室内系列
Indoor series 24

尚蒙

不仅是一个企业, 更是一项事业

SUNMOON

我们不仅造灯 更是造光



25 室内系列
Indoor series



ML1512-700

Input Current 输入电参数: AC 100-240V 50/60Hz
 Driver 驱动装置: DC 700mA 28-50V
 Power(Watts) 灯具功率: 27W
 Color Temperature 发光颜色/色温: 3000K/4000K/6000K
 IP level 防水等级: IP20
 Class 防触电保护等级: I II III
 Specification 外箱规格
 L 长: 77 cm
 W 宽: 22 cm
 H 高: 83 cm
 Qty/Ctn 数量: 1



ML1512-430

Input Current 输入电参数: AC 100-240V 50/60Hz
 Driver 驱动装置: DC 700mA 28-50V
 Power(Watts) 灯具功率: 27W
 Color Temperature 发光颜色/色温: 3000K/4000K/6000K
 IP level 防水等级: IP20
 Class 防触电保护等级: I II III
 Specification 外箱规格
 L 长: 50 cm
 W 宽: 22 cm
 H 高: 55 cm
 Qty/Ctn 数量: 1



Body Color 灯体颜色



室内系列
Indoor series 26

+ (86) 186-8880-7020

尚蒙

不仅是一个企业,更是一项事业

SUNMOON

我们不仅造灯 更是造光

IMEXAO IMPORTERS EXPORTERS

+ (86) 186-8880-7020

SQ1505

Input Current 输入电参数:	AC 220-240V 50/60Hz
Driver 驱动装置:	DC 700mA 2.8-7V
Power(Watts) 灯具功率:	2*2.5W
Color Temperature 发光颜色/色温:	3000K/4000K/6000K
IP level 防水等级:	IP65
Class 防触电保护等级:	<input type="checkbox"/> I <input checked="" type="checkbox"/> II <input type="checkbox"/> III
Specification 外箱规格	
L 长:	48 cm
W 宽:	47 cm
H 高:	35 cm
Qty/Ctn 数量:	12

Body Color 灯体颜色

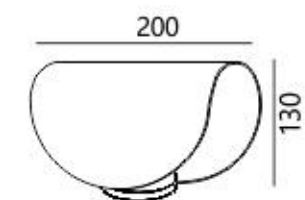

户外系列
2 | Outdoor series

户外系列
Outdoor series 2 2

AL-5 B-14



AL-5 □□1336-5



AL-5 SF005-1



AL-5 □□1336-3

+ (86) 186-8880-7020



AL-5 SF1336-7A



AL-5 □□1381



AL-5 □□1382

+ (86) 186 8880-7020



AL-5 SF1383



AL-5 □□ 002-1



**AL-5
□□ 809**

IMPORTERS EXPORTERS

(86) 186-8880-7020

"Let us help to build your dreams"



ITEM NO.	ØX HMMET	ØX HMM4L2	ØX HMM4L4
WAFTS	7W	20W	30W
VOLTAGE	AC 100-240V	AC 100-240V	AC 100-240V
LUMENS	500LM	1600LM	2000LM
CCT	3000K,4000K,5000K	3000K,4000K,5000K	3000K,4000K,5000K
CRU	80/90	80/90	80/90
BEAM ANGLE	180°	180°	180°
HOUSING COLOR	WH	WH	WH
FRAME SIZE	Ø130MM	Ø150MM	Ø200MM

ITEM NO.	ØX HMM20R	ØX HMM22L	ØX HMM22R
WAFTS	8W	12W	20W
VOLTAGE	AC 100-240V	AC 100-240V	AC 100-240V
LUMENS	600LM	900LM	1800LM
CCT	3000K,4000K,5000K	3000K,4000K,5000K	3000K,4000K,5000K
CRU	80/90	80/90	80/90
BEAM ANGLE	180°	180°	180°
HOUSING COLOR	WH	WH	WH
FRAME SIZE	120x120MM	120x120MM	220x120MM



ITEM NO.	ØX HMM20R	ØX HMM22L	ØX HMM22R	ØX HMM22R
WAFTS	8W	12W	20W	20W
VOLTAGE	AC 100-240V	AC 100-240V	AC 100-240V	AC 100-240V
LUMENS	600LM	900LM	1800LM	2000LM
CCT	3000K,4000K,5000K	3000K,4000K,5000K	3000K,4000K,5000K	3000K,4000K,5000K
CRU	80/90	80/90	80/90	80/90
BEAM ANGLE	180°	180°	180°	180°
HOUSING COLOR	WH	WH	WH	WH
FRAME SIZE	Ø100MM	Ø140MM	Ø120MM	Ø180MM
CUT SIZE	Ø100MM	Ø120MM	Ø120MM	Ø180MM

ITEM NO.	ØX HMM15L	ØX HMM15R	ØX HMM15L	ØX HMM15L	ØX HMM15L
WAFTS	5W	7W	20W	20W	20W
VOLTAGE	AC 100-240V	AC 100-240V	AC 100-240V	AC 100-240V	AC 100-240V
LUMENS	600LM	700LM	1700LM	2000LM	2000LM
CCT	3000K,4000K,5000K	3000K,4000K,5000K	3000K,4000K,5000K	3000K,4000K,5000K	3000K,4000K,5000K
CRU	80/90	80/90	80/90	80/90	80/90
BEAM ANGLE	180°	180°	180°	180°	180°
HOUSING COLOR	WH	WH	WH	WH	WH
FRAME SIZE	90x90MM	140x140MM	120x120MM	220x120MM	220x120MM
CUT SIZE	90x90MM	120x120MM	120x120MM	220x120MM	220x120MM



ITEM NO.	ØX HMM20R	ØX HMM22L	ØX HMM22R	ØX HMM22R	ØX HMM22R
WAFTS	8W	12W	20W	20W	20W
VOLTAGE	AC 100-240V	AC 100-240V	AC 100-240V	AC 100-240V	AC 100-240V
LUMENS	240LM	480LM	800LM	1400LM	1200LM
CCT	3000K,4000K,5000K	3000K,4000K,5000K	3000K,4000K,5000K	3000K,4000K,5000K	3000K,4000K,5000K
CRU	80/90	80/90	80/90	80/90	80/90
BEAM ANGLE	180°	180°	180°	180°	180°
HOUSING COLOR	WH	WH	WH	WH	WH
FRAME SIZE	Ø80MM	Ø120MM	Ø120MM	Ø120MM	Ø120MM
CUT SIZE	Ø70MM	Ø110MM	Ø100MM	Ø100MM	Ø100MM

ITEM NO.	ØX HMM20R	ØX HMM22L	ØX HMM22R	ØX HMM22R	ØX HMM22R
WAFTS	8W	12W	20W	20W	20W
VOLTAGE	AC 100-240V	AC 100-240V	AC 100-240V	AC 100-240V	AC 100-240V
LUMENS	140LM	400LM	800LM	1400LM	1200LM
CCT	3000K,4000K,5000K	3000K,4000K,5000K	3000K,4000K,5000K	3000K,4000K,5000K	3000K,4000K,5000K
CRU	80/90	80/90	80/90	80/90	80/90
BEAM ANGLE	180°	180°	180°	180°	180°
HOUSING COLOR	WH	WH	WH	WH	WH
FRAME SIZE	Ø100MM	120x120MM	120x120MM	220x120MM	220x120MM
CUT SIZE	70x70MM	110x110MM	100x100MM	210x110MM	220x120MM



Track LIGHT SERIES



显色指数/CRI:≥80 光通量/Luminous Flux:95lm/W 安装方式/Installment type:轨道式

型号 MODEL	电压 VOLTAGE	功率 POWER	频率 FREQUENCY	尺寸(mm) DIMENSION	色温 CCT	光束角 BEAM ANGLE	材料 MATERIAL	灯体 HOUSING
XN-GD2830-1	AC 100-260V	30W	50-60Hz	Ø110xL154xH180	3000K 4000K 6000K	24° 40°	Aluminum	WH BL SY
XN-GD2840-1	AC 100-260V	40W	50-60Hz	Ø110xL154xH180	3000K 4000K 6000K	24° 40°	Aluminum	WH BL SY



显色指数/CRI:≥80 光通量/Luminous Flux:95lm/W 安装方式/Installment type:轨道式

型号 MODEL	电压 VOLTAGE	功率 POWER	频率 FREQUENCY	尺寸(mm) DIMENSION	色温 CCT	光束角 BEAM ANGLE	材料 MATERIAL	灯体 HOUSING
XN-GD3020-1	AC 100-260V	20W	50-60Hz	Ø80xL130xH180	3000K 4000K 6000K	24° 40°	Aluminum	WH BL SY
XN-GD3030-1	AC 100-260V	30W	50-60Hz	Ø80xL130xH180	3000K 4000K 6000K	24° 40°	Aluminum	WH BL SY

AL-7 2

IMEXAO
IMPORTERS EXPORTERS

"Let us help to build your dreams"

+ (86) 186-8880-7020

LED CEILING LIGHT

"Let us help to build your dreams"



ITEM NO.	XN-TH1401	XN-TH1405	XN-TH1407	XN-TH1410
WATTS	3W	5W	7W	30W
VOLTAGE	AC 100-240V	AC 100-240V	AC 100-240V	AC 100-240V
LUMENS	240LM	480LM	560LM	800LM
CCT	3000K/4000K/6000K	3000K/4000K/6000K	3000K/4000K/6000K	3000K/4000K/6000K
CFR	80/90	80/90	80/90	80/90
BEAM ANGLE	15°/24°/38°	15°/24°/38°	15°/24°/38°	15°/24°/38°
HOUSING COLOR	WH/BL/YS	WH/BL/YS	WH/BL/YS	WH/BL/YS
DIMENSION	Φ90×H45mm	Φ90×H45mm	Φ100×H45mm	Φ110×H45mm
CUT SIZE	Φ75mm	Φ75mm	Φ90mm	Φ90mm

ITEM NO.	XN-TH1501	XN-TH1505	XN-TH1507	XN-TH1510
WATTS	3W	5W	7W	30W
VOLTAGE	AC 100-240V	AC 100-240V	AC 100-240V	AC 100-240V
LUMENS	240LM	480LM	560LM	800LM
CCT	3000K/4000K/6000K	3000K/4000K/6000K	3000K/4000K/6000K	3000K/4000K/6000K
CFR	80/90	80/90	80/90	80/90
BEAM ANGLE	15°/24°/38°	15°/24°/38°	15°/24°/38°	15°/24°/38°
HOUSING COLOR	WH/BL/YS	WH/BL/YS	WH/BL/YS	WH/BL/YS
DIMENSION	Φ90×H45mm	Φ90×H45mm	Φ100×H45mm	Φ110×H45mm
CUT SIZE	Φ75mm	Φ75mm	Φ90mm	Φ90mm



ITEM NO.	XN-00110-1	XN-00120-1	XN-00130-1	XN-00140-1
WATTS	15W	20W	30W	40W
VOLTAGE	AC 100-240V	AC 100-240V	AC 100-240V	AC 100-240V
LUMENS	1700LM	1800LM	2700LM	3600LM
CFR	95+	95+	95+	95+
CCT	3000K/4000K/6000K	3000K/4000K/6000K	3000K/4000K/6000K	3000K/4000K/6000K
BEAM ANGLE	15°/24°/38°	15°/24°/38°	15°/24°/38°	15°/24°/38°
HOUSING COLOR	WH/BL/YS	WH/BL/YS	WH/BL/YS	WH/BL/YS
DIMENSION	Φ80×L130mm×H120mm	Φ100×L140mm×H120mm	Φ120×L150mm×H120mm	Φ120×L170mm×H120mm

ITEM NO.	XN-00110-2	XN-00120-2	XN-00130-2	XN-00140-2
WATTS	15W	20W	30W	40W
VOLTAGE	AC 100-240V	AC 100-240V	AC 100-240V	AC 100-240V
LUMENS	1700LM	1800LM	2700LM	3600LM
CFR	95+	95+	95+	95+
CCT	3000K/4000K/6000K	3000K/4000K/6000K	3000K/4000K/6000K	3000K/4000K/6000K
BEAM ANGLE	15°/24°/38°	15°/24°/38°	15°/24°/38°	15°/24°/38°
HOUSING COLOR	WH/BL/YS	WH/BL/YS	WH/BL/YS	WH/BL/YS
DIMENSION	Φ80×L130mm×H120mm	Φ100×L140mm×H120mm	Φ120×L150mm×H120mm	Φ120×L170mm×H120mm

LED TRACK LIGHT



ITEM NO.	XN-G0210-1	XN-G0210-1	XN-G0210-1
WATTS	20W	30W	40W
VOLTAGE	AC 100-240V	AC 100-240V	AC 100-240V
LUMENS	1700LM	2400LM	3600LM
CFR	95+	95+	95+
CCT	3000K/4000K/6000K	3000K/4000K/6000K	3000K/4000K/6000K
BEAM ANGLE	15°/24°/38°	15°/24°/38°	15°/24°/38°
HOUSING COLOR	WH/BL/YS	WH/BL/YS	WH/BL/YS
DIMENSION	Φ80×L120mm×H100mm	Φ80×L120mm×H100mm	Φ80×L120mm×H100mm

ITEM NO.	XN-G0210-2	XN-G0210-2	XN-G0210-2
WATTS	20W	30W	40W
VOLTAGE	AC 100-240V	AC 100-240V	AC 100-240V
LUMENS	1700LM	2400LM	3600LM
CFR	95+	95+	95+
CCT	3000K/4000K/6000K	3000K/4000K/6000K	3000K/4000K/6000K
BEAM ANGLE	15°/24°/38°	15°/24°/38°	15°/24°/38°
HOUSING COLOR	WH/BL/YS	WH/BL/YS	WH/BL/YS
DIMENSION	Φ80×L120mm×H100mm	Φ80×L120mm×H100mm	Φ80×L120mm×H100mm



ITEM NO.	XN-G0210-1	XN-G0210-1	XN-G0210-1	XN-G0210-1
WATTS	20W	30W	30W+J	30W+J
VOLTAGE	AC 100-240V	AC 100-240V	AC 100-240V	AC 100-240V
LUMENS	1700LM	1800LM	2700LM	3600LM
CFR	95+	95+	95+	95+
CCT	3000K/4000K/6000K	3000K/4000K/6000K	3000K/4000K/6000K	3000K/4000K/6000K
BEAM ANGLE	15°/24°/38°	15°/24°/38°	15°/24°/38°	15°/24°/38°
HOUSING COLOR	WH/BL/YS	WH/BL/YS	WH/BL/YS	WH/BL/YS
DIMENSION	Φ80×L120mm×H100mm	Φ80×L120mm×H100mm	Φ100×L130mm×H100mm	Φ100×L130mm×H100mm

ITEM NO.	XN-G0210-1	XN-G0210-1	XN-G0210-2	XN-G0210-2
WATTS	20W	30W	30W+J	30W+J
VOLTAGE	AC 100-240V	AC 100-240V	AC 100-240V	AC 100-240V
LUMENS	1700LM	1800LM	2700LM	3600LM
CFR	95+	95+	95+	95+
CCT	3000K/4000K/6000K	3000K/4000K/6000K	3000K/4000K/6000K	3000K/4000K/6000K
BEAM ANGLE	15°/24°/38°	15°/24°/38°	15°/24°/38°	15°/24°/38°
HOUSING COLOR	WH/BL/YS	WH/BL/YS	WH/BL/YS	WH/BL/YS
DIMENSION	Φ80×L120mm×H100mm	Φ80×L120mm×H100mm	Φ100×L130mm×H100mm	Φ100×L130mm×H100mm



ITEM NO.	XN-G0210	XN-G0210	XN-G0210
WATTS	20W	30W	40W
VOLTAGE	AC 100-240V	AC 100-240V	AC 100-240V
LUMENS	1800LM	2700LM	3600LM
CFR	95+	95+	95+
CCT	3000K/4000K/6000K	3000K/4000K/6000K	3000K/4000K/6000K
BEAM ANGLE	15°/24°/38°	15°/24°/38°	15°/24°/38°
HOUSING COLOR	WH/BL/YS	WH/BL/YS	WH/BL/YS
DIMENSION	Φ105×L140mm×H110mm	Φ125×L160mm×H110mm	Φ105×L140mm×H110mm

ITEM NO.	XN-G0210	XN-G0210	XN-G0210
WATTS	20W	30W	40W
VOLTAGE	AC 100-240V	AC 100-240V	AC 100-240V
LUMENS	1800LM	2700LM	3600LM
CFR	95+	95+	95+
CCT	3000K/4000K/6000K	3000K/4000K/6000K	3000K/4000K/6000K
BEAM ANGLE	15°/24°/38°	15°/24°/38°	15°/24°/38°
HOUSING COLOR	WH/BL/YS	WH/BL/YS	WH/BL/YS
DIMENSION	Φ105×L140mm×H110mm	Φ125×L160mm×H110mm	Φ105×L140mm×H110mm



ITEM NO.	XN-G0210	XN-G0210	XN-G0210	XN-G0210
WATTS	15W	20W	30W	40W
VOLTAGE	AC 100-240V	AC 100-240V	AC 100-240V	AC 100-240V
LUMENS	1800LM	2700LM	3600LM	4800LM
CFR	95+	95+	95+	95+
CCT	3000K/4000K/6000K	3000K/4000K/6000K	3000K/4000K/6000K	3000K/4000K/6000K
BEAM ANGLE	15°/24°/38°	15°/24°/38°	15°/24°/38°	15°/24°/38°
HOUSING COLOR	WH/BL/YS	WH/BL/YS	WH/BL/YS	WH/BL/YS
DIMENSION	Φ80×L120mm×H100mm	Φ80×L120mm×H100mm	Φ100×L130mm×H100mm	Φ100×L130mm×H100mm

ITEM NO.	XN-G0210	XN-G0210	XN-G0210	XN-G0210
WATTS	15W	20W	30W	40W
VOLTAGE	AC 100-240V	AC 100-240V	AC 100-240V	AC 100-240V
LUMENS	1800LM	2700LM	3600LM	4800LM
CFR	95+	95+	95+	95+
CCT	3000K/4000K/6000K	3000K/4000K/6000K	3000K/4000K/6000K	3000K/4000K/6000K
BEAM ANGLE	15°/24°/38°	15°/24°/38°	15°/24°/38°	15°/24°/38°
HOUSING COLOR	WH/BL/YS	WH/BL/YS	WH/BL/YS	WH/BL/YS
DIMENSION	Φ80×L120mm×H100mm	Φ80×L120mm×H100mm	Φ100×L130mm×H100mm	Φ100×L130mm×H100mm

AL-7 3

(86) 186-8880-7020

Thank You

We appreciate your time and attention. If you have any questions or need further information, please feel free to reach out.

 **CHINA OFFICE**

Room 19, 2nd Floor DeYi Commercial Building Construction Road No. 4th, Lecong Town Shunde Foshan, Guangdong, Postal code: 528 315

佛山市顺德区乐从镇建设路四号德怡商业大厦北门二楼19-3铺 528315

 + (86) 186-8880-7020  goldy@imexao.com



@imexao