



利华高贸易有限公司

Hospital Furniture Catalogue 2024

SAMPLE 1

BUILD YOUR DREAMS WITH RELIABLE SOURCING FROM CHINA

 www.imexao.com

for
19+ YEARS



HSP-1 1

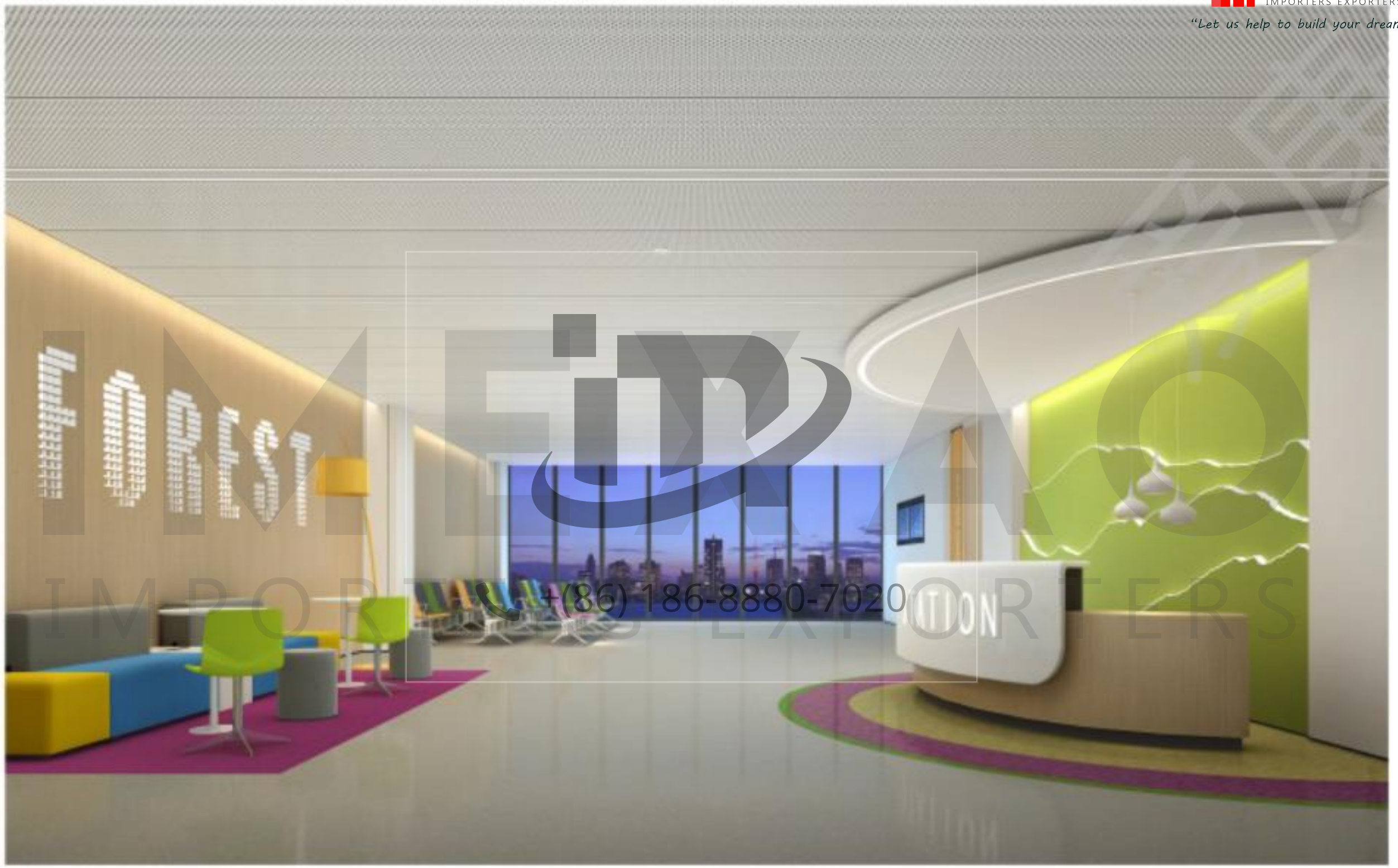

HSP-1 2



HSP-1 3

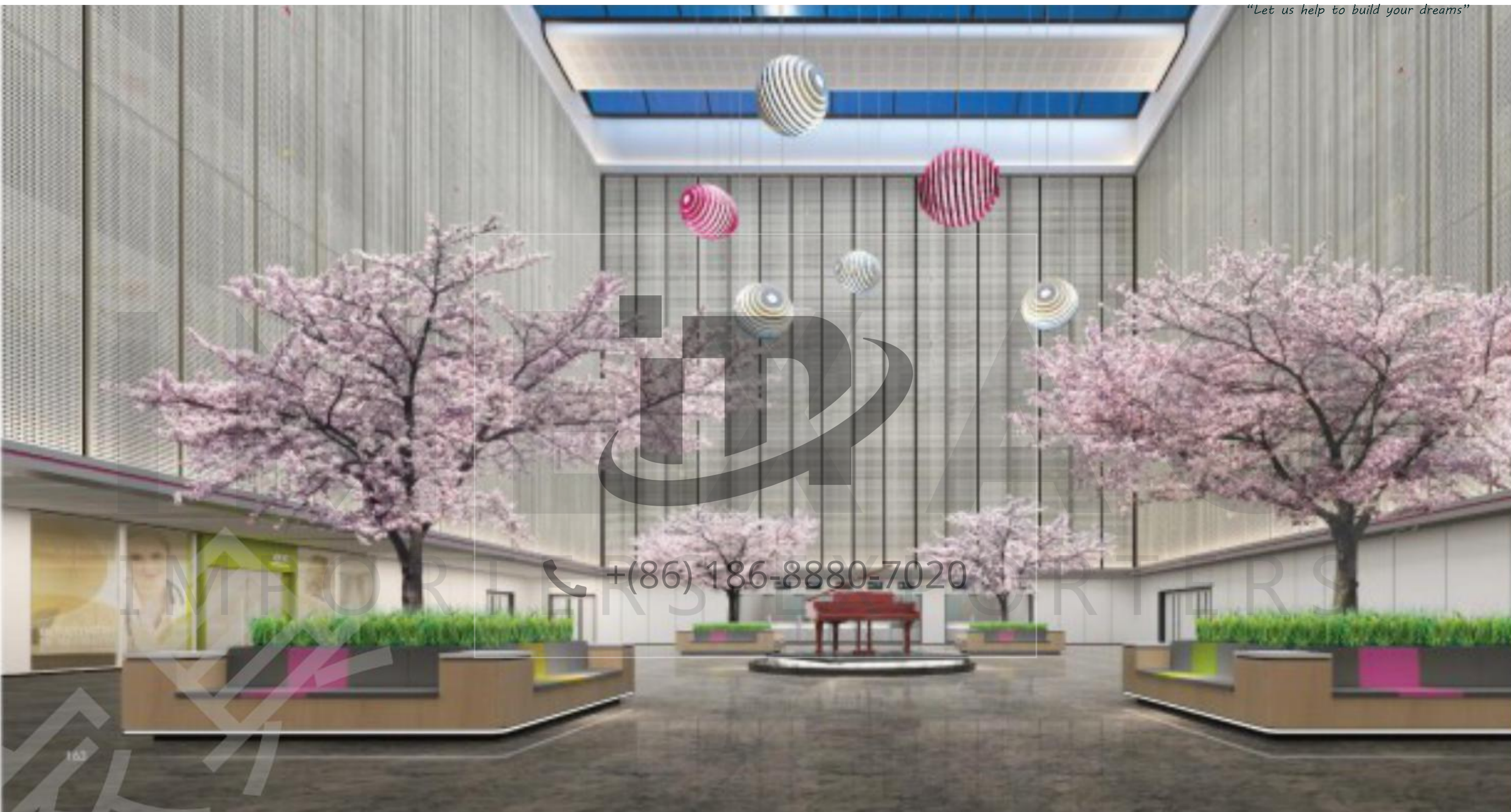

+ (86) 186-8880-7020

HSP-1 4



+ (86) 186-8880-7020

HSP-1 5



HSP-1 6



+ (86) 186-8880-7020

HSP-1 7



+ (86) 186-8880-7020

HSP-1 8



+ (86) 186-8880-7020

HSP-1 9



 [+\(86\) 186-8880-7020](tel:+8618688807020)

HSP-1 10



+ (86) 186-8880-7020

● 护士站 02 L形
W(5400+1500)*D700*H1100

HSP-1 11



IMPORTERS EXPORTERS [+\(86\) 186-8880-7020](tel:+8618688807020) IMPORTERS EXPORTERS

• 护士站 03 L形
W(6000+1600)*D700*H1100

HSP-1 12



HSP-1 13



 [+\(86\) 186-8880-7020](tel:+8618688807020)



HSP-1 15



+ (86) 186-8880-7020

HSP-1 16



+ (86) 186-8880-7020

● 套间病房

HSP-1 17



+ (86) 186-8880-7020

HSP-1 18



+ (86) 186-8880-7020



+ (86) 186-8880-7020

● 儿科护士站 2 弧形
W36800*D1620*H1050

HSP-1 20



HSP-1 21



HSP-1 22

BS-858 五功能豪华电动护理床
Five-function Electric Medical Bed

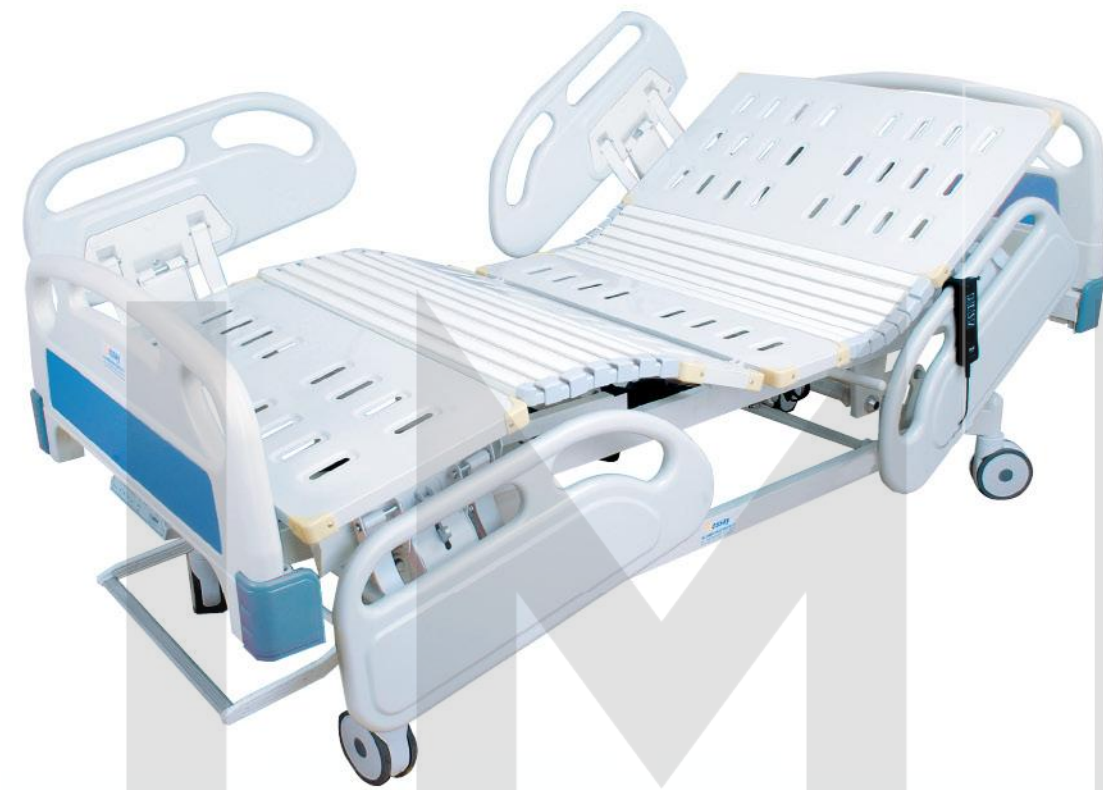

BS-858B 五功能豪华电动护理床
Five-function Electric Medical Bed



规格:
2120*970*500/700mm

- 标准配置:**
- 高级电机系统 (台湾Timotion(提摩讯)电机四个, 电控箱一个, 控制手柄一个)
 - 中控脚轮刹车系统
 - 软连接床面板
 - 点滴架插孔每侧二个, 引流挂钩每侧二个, 输液杆一支

- 功能:**
- 高-低: 500mm--700mm
 - 背部角度 0-80°(±5°)
 - 膝部角度 0-40°(±5°)
 - 倾斜角度: 0-12°

- 可选配:**
- 床垫; 餐桌; 后备电源;
 - 快速放倒功能 (CPR)
 - 护士控制系列 (ACP)
 - 丹麦LINAK (力纳克) 安全电压电机或台湾LINCOLN (林肯) 电机

Specifications:
2120*970*500/700mm

- Standard Configuration:**
- Advanced medical motor system(4 pcs Taiwan Timotionmotors,1 pcs control box,1 pcs handset)
 - Central-controlled castor brake system
 - Bed board with flexible connection
 - Urine hooks,I.V drip

- Function:**
- Height adjustable from 500 to 700mm
 - Back-rest lifting angle is 0-80°(±5°)
 - Knee-rest lifting angle is 0-40°(±5°)
 - Trendelenburg &Rev.Trendelenburg are 0-12°

- Optional configuration:**
- Mattress,Mobile food table,Back-up power system(UPS)
 - Quick fold down system(CPR)
 - Nurse control system(ACP)
 - Danmark LINAK safety voltage motor or Taiwan LINCOLN safety voltage motor

规格:
2120*970*500/700mm

- 标准配置:**
- 高级电机系统 (台湾 Timotion(提摩讯)电机四个, 电控箱一个, 控制手柄一个)
 - 中控脚轮刹车系统
 - 点滴架插孔每侧二个, 引流挂钩每侧二个, 输液杆一支

- 功能:**
- 高-低: 500mm--700mm
 - 背部角度 0-80°(±5°)
 - 膝部角度 0-40°(±5°)
 - 倾斜角度: 0-12°

- 可选配:**
- 床垫; 餐桌; 后备电源;
 - 快速放倒功能 (CPR)
 - 护士控制系列 (ACP)
 - 丹麦LINAK (力纳克) 安全电压电机或台湾LINCOLN (林肯) 电机

Specifications:
2120*970*500/700mm

- Standard Configuration:**
- Advanced medical motor system(4 pcs Taiwan Timotionmotors,1 pcs control box,1 pcs handset)
 - Central-controlled castor brake system
 - Urine hooks,I.V drip

- Function:**
- Height adjustable from 500 to 700mm
 - Back-rest lifting angle is 0-80°(±5°)
 - Knee-rest lifting angle is 0-40°(±5°)
 - Trendelenburg &Rev.Trendelenburg are 0-12°

- Optional configuration:**
- Mattress,Mobile food table,Back-up power system(UPS)
 - Quick fold down system(CPR)
 - Nurse control system(ACP)
 - Danmark LINAK safety voltage motor or Taiwan LINCOLN safety voltage motor

+ (86) 186-8880-7000

BS-835 三功能豪华电动加手摇护理床
Three-function Electric&Manual Medical Bed



BS-836 三功能豪华电动护理床
Three-function Electric Medical Bed



规格:
2120*970*450/700mm

标准配置:

- 高级电机系统 (丹麦LINAK(力纳克)电机三个, 电控箱一个、控制手柄一个)
- 不锈钢护栏一对, 中控制脚刹车系统
- 点滴架插孔每侧三个, 引流挂钩每侧二个, 输液杆一支

功能:

- 高--低: 450mm--700mm
- 背部角度 0-80°(±5°)
- 膝部角度 0-40°(±5°)

可选配:

- 床垫; 餐桌; 后备电源;
- 快速放倒功能 (CPR)
- 护士控制系列 (ACP)
- 台湾Timotion(堤摩讯) 安全电压电机或台湾LINCOLN (林肯) 电机

Specifications:
2120*970*450/700mm

Standard Configuration:

- Advanced medical motor system(3 pcs Danmark LINAK motors,1 pcs control box,1 pcs handset)
- Central-controlled castor brake system
- Urine hooks,I.V drip

Function:

- Height adjustable from 450 to 700mm
- Back-rest lifting angle is 0-80°(±5°)
- Knee-rest lifting angle is 0-40°(±5°)

Optional configuration:

- Mattress,Mobile food table,Back-up power system(UPS)
- Quick fold down system(CPR)
- Nurse control system(ACP)
- TaiWan Timotion safety voltage motor or Taiwan LINCOLN safety voltage motor



电机:

采用LINAK系列医疗专用电机, 极低的噪音等级, 有过载保护功能, 安全可靠。

Actuator:

LINAK special medical treatment actuator,quiet,protect while overweight,safe,reliable

规格:
2120*970*450/700mm

标准配置:

- 高级电机系统 (台湾Timotion(堤摩讯)电机三个, 电控箱一个、控制手柄一个)
- 铝合金护栏一对
- 采用125mm高静音, 单触式手柄操作
- 点滴架插孔每侧三个, 引流挂钩每侧二个, 输液杆一支

功能:

- 高--低: 450mm--700mm
- 背部角度 0-80°(±5°)
- 膝部角度 0-40°(±5°)

可选配:

- 床垫; 餐桌; 后备电源;
- 护士操作器 (ACP)
- 快速放倒功能 (CPR)
- 丹麦LINAK (力纳克) 安全电压电机或台湾LINCOLN (林肯) 电机

Specifications:
2120*970*450/700mm

Standard Configuration:

- Advanced medical motor system(3 pcs Taiwan Timotion motors,1 pcs control box,1 pcs handset)
- Aluminum folding side rail
- 125mm dia.Noiseless castors with brake
- Urine hooks,I.V drip

Function:

- Height adjustable from 450 to 700mm
- Back-rest lifting angle is 0-80°(±5°)
- Knee-rest lifting angle is 0-40°(±5°)

Optional configuration:

- Mattress,Mobile food table,Back-up power system(UPS)
- Nurse control system(ACP)
- Quick fold down system(CPR)
- Danmark LINAK safety voltage motor or Taiwan LINCOLN safety voltage motor

BS-836T 三功能豪华电动护理床
Three-function Electric Manual Bed



规格:
2120*970*450/700mm

- 标准配置:**
- 高级电机系统 (台湾Timotion(堤摩讯)电机三个, 电控箱一个, 控制手柄一个)
 - 铝合金护栏一对
 - 采用125mm高静音, 单触式手柄操作
 - 点滴架插孔每侧三个, 引流挂钩每侧二个, 输液杆一支
 - 餐桌

- 功能:**
- 高-低: 450mm--700mm
 - 背部角度 0-80°(±5°)
 - 膝部角度 0-40°(±5°)

- 可选配:**
- 床垫; 餐桌; 后备电源;
 - 护士操作器 (ACP)
 - 快速放倒功能 (CPR)
 - 丹麦LINAK (力纳克) 安全电压电机或台湾LINCOLN (林肯) 电机

- Specifications:**
2120*970*450/700mm
- Standard Configuration:**
- Advanced medical motor system(3 pcs Taiwan Timotion motors, 1 pcs control box, 1 pcs handset)
 - Aluminum folding side rail
 - 125mm dia.Noiseless castors with brake
 - Urine hooks,I.V drip
 - Folding food table

- Function:**
- Height adjustable from 450 to 700mm
 - Back-rest lifting angle is 0-80°(±5°)
 - Knee-rest lifting angle is 0-40°(±5°)

- Optional configuration:**
- Mattress,Mobile food table,Back-up power system(UPS)
 - Nurse control system(ACP)
 - Quick fold down system(CPR)
 - Danmark LINAK safety voltage motor or Taiwan LINCOLN safety voltage motor

BS-836M 三功能豪华电动超低护理床
Luxurious Ultra Low Electric Bed with three Functions



- 规格:**
2120*970*180/600mm
- 标准配置:**
- 高级电机系统 (台湾 Timotion(堤摩讯)电机三个, 电控箱一个, 控制手柄一个)
 - 铝合金护栏一对
 - 采用125mm高静音, 单触式手柄操作
 - 点滴架插孔每侧三个, 引流挂钩每侧二个, 输液杆一支
 - 猴子拉杆

- 功能:**
- 高-低: 180mm--600mm
 - 背部角度 0-80°(±5°)
 - 膝部角度 0-40°(±5°)

- 可选配:**
- 床垫; 餐桌; 后备电源;
 - 护士操作器 (ACP)
 - 快速放倒功能 (CPR)
 - 丹麦LINAK (力纳克) 安全电压电机或台湾LINCOLN (林肯) 电机

- Specifications:**
2120*970*180/600mm
- Standard Configuration:**
- Advanced medical motor system(3 pcs Taiwan Timotion motors, 1 pcs control box, 1 pcs handset)
 - Aluminum folding side rail
 - 125mm dia.Noiseless castors with brake
 - Urine hooks,I.V drip
 - Money Pole

- Function:**
- Height adjustable from 180 to 600mm
 - Back-rest lifting angle is 0-80°(±5°)
 - Knee-rest lifting angle is 0-40°(±5°)

- Optional configuration:**
- Mattress,Mobile food table,Back-up power system(UPS)
 - Nurse control system(ACP)
 - Quick fold down system(CPR)
 - Danmark LINAK safety voltage motor or Taiwan LINCOLN safety voltage motor

BS-821 二功能豪华电动护理床
Luxurious Electric Bed with Two Functions



BS-810 一功能豪华电动护理床
Luxurious Electric Bed with One Functions



规格:
2120*970*530mm

标准配置:

- 高级电机系统 (台湾Timotion(堤摩讯) 电机两个, 电控箱一个, 控制手柄一个)
- 铝合金护栏一对
- 采用125mm高静音, 单触式手柄操作
- 点滴架插孔每侧三个, 引流挂钩每侧二个, 输液杆一支

功能:

- 背部角度 0-80°(±5°)
- 膝部角度 0-40°(±5°)

可选配:

- 床垫; 餐桌; 后备电源;
- 护士操作器 (ACP)
- 快速放倒功能 (CPR)
- 丹麦LINAK (力纳克) 安全电压电机或台湾LINCOLN (林肯) 电机

Specifications:
2120*970*530mm

Standard Configuration:

- Advanced medical motor system(2 pcs Taiwan Timotion motors,1 pcs control box,1 pcs handset)
- Aluminum folding side rail
- 125mm dia.Noiseless castors with brake
- Urine hooks,I.V drip

Function:

- Back-rest lifting angle is 0-80°(±5°)
- Knee-rest lifting angle is 0-40°(±5°)

Optional configuration:

- Mattress,Mobile food table,Back-up power system(UPS)
- Nurse control system(ACP)
- Quick fold down system(CPR)
- Danmark LINAK safety voltage motor or Taiwan LINCOLN safety voltage motor

+ (86) 186-8880-7020

规格:
2120*970*530mm

标准配置:

- 高级电机系统 (台湾Timotion(堤摩讯) 电机一个, 电控箱一个, 控制手柄一个)
- 铝合金护栏一对
- 采用125mm高静音, 单触式手柄操作
- 点滴架插孔每侧三个, 引流挂钩每侧二个, 输液杆一支

功能:

- 背部角度 0-80°(±5°)

可选配:

- 床垫; 餐桌; 后备电源;
- 护士操作器 (ACP)
- 快速放倒功能 (CPR)
- 丹麦LINAK (力纳克) 安全电压电机或台湾LINCOLN (林肯) 电机

Specifications:
2120*970*530mm

Standard Configuration:

- Advanced medical motor system(1 pcs Taiwan Timotion motors,1 pcs control box,1 pcs handset)
- Aluminum folding side rail
- 125mm dia.Noiseless castors with brake
- Urine hooks,I.V drip

Function:

- Back-rest lifting angle is 0-80°(±5°)

Optional configuration:

- Mattress,Mobile food table,Back-up power system(UPS)
- Nurse control system(ACP)
- Quick fold down system(CPR)
- Danmark LINAK safety voltage motor or Taiwan LINCOLN safety voltage motor

BS-838 ABS三摇护理床
Hospital Bed with Three Revolving Levers 

BS-839 ABS三摇护理床
Hospital Bed with Three Revolving Levers 

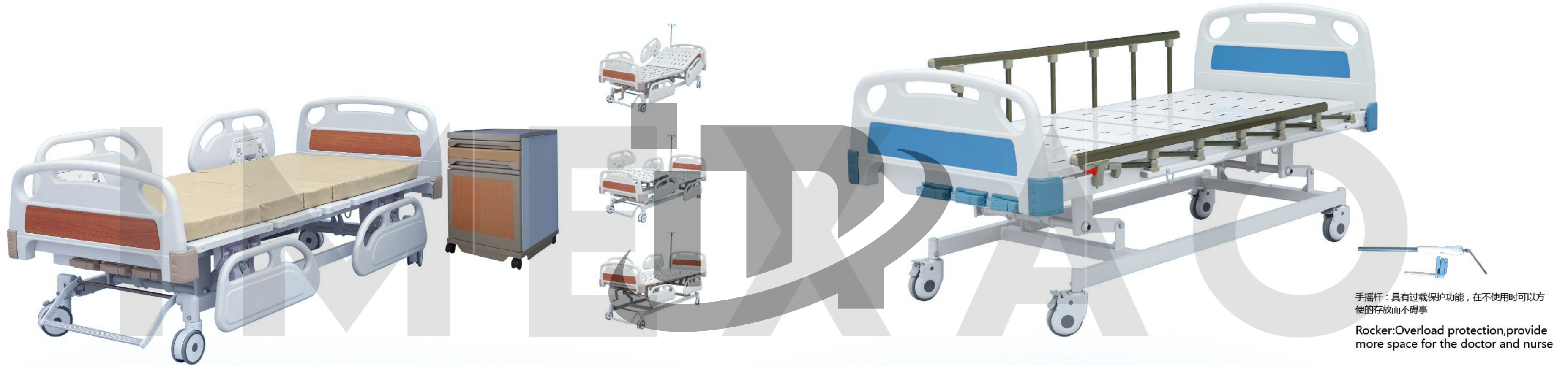

手摇杆：具有过载保护功能，在不使用时可以方便的存放而不碍事

Rocker: Overload protection, provide more space for the doctor and nurse

规格:

2120*970*450/700mm

标准配置:

- 手动摇杆弹簧拉力系统
- 中控脚轮刹车系统
- 点滴架插孔每侧二个，引流挂钩每侧二个，输液杆一支

功能:

- 高-低：450mm--700mm
- 背部角度 0-80°(±5°)
- 膝部角度 0-40°(±5°)

可选配:

- 床垫；餐桌；

Specifications:

2120*970*450/700mm

Standard Configuration:

- Manual crank spring tensioning system
- Central-controlled castor brake system
- Urine hooks, I.V drip

Function:

- Height adjustable from 450 to 700mm
- Back-rest lifting angle is 0-80°(±5°)
- Knee-rest lifting angle is 0-40°(±5°)

Optional configuration:

- Mattress, Mobile food table

+ (86) 186-8880-7020

规格:

2120*970*450/700mm

标准配置:

- 手动摇杆弹簧拉力系统
- 铝合金护栏一对
- 四轮采用125mm全制脚轮
- 点滴架插孔每侧二个，引流挂钩每侧二个，输液杆一支

功能:

- 高-低：450mm--700mm
- 背部角度 0-80°(±5°)
- 膝部角度 0-40°(±5°)

可选配:

- 床垫；餐桌；

Specifications:

2120*970*450/700mm

Standard Configuration:

- Manual crank spring tensioning system
- Aluminium folding side rails
- 125mm dia.Noiseless castors with brake
- Urine hooks, I.V drip

Function:

- Height adjustable from 450 to 700mm
- Back-rest lifting angle is 0-80°(±5°)
- Knee-rest lifting angle is 0-40°(±5°)

Optional configuration:

- Mattress, Mobile food table

BS-828A ABS二摇护理床
Hospital Bed with Two Revolving Levers



BS-829 二摇护理床
Hospital Bed with Two Revolving Levers



规格:
2120*970*530mm

标准配置:

- 手动摇杆弹簧拉力系统
- 铝合金护栏一对
- 四轮采用125mm全制动脚轮
- 点滴架插孔每侧三个, 引流挂钩每侧二个, 输液杆一支

功能:

- 背部角度 0-80°(±5°)
- 膝部角度 0-40°(±5°)

可选配:

- 床垫; 餐桌;

Specifications:
2120*970*530mm

Standard Configuration:

- Manual crank spring tensioning system
- Aluminium alloy folding side rails
- 125mm dia.Noiseless castors with brake
- Urine hooks,I.V drip

Function:

- Back-rest lifting angle is 0-80°(±5°)
- Knee-rest lifting angle is 0-40°(±5°)

Optional configuration:

- Mattress,Mobile food table



BS-828B

+ (86) 186-8880-7020

规格:
2070*900*530mm

标准配置:

- 手动摇杆弹簧拉力系统
- 点滴架插孔每侧两个, 引流挂钩每侧三个, 输液杆一支

可选配:

- 床垫; 餐桌

Specifications:
2070*900*530mm

Standard Configuration:

- Manual crank spring tensioning system
- Urine hooks,I.V drip

Optional configuration:

- Mattress;Mobile food table

BS-818 ABS单摇护理床
Hospital Bed with One Revolving Levers

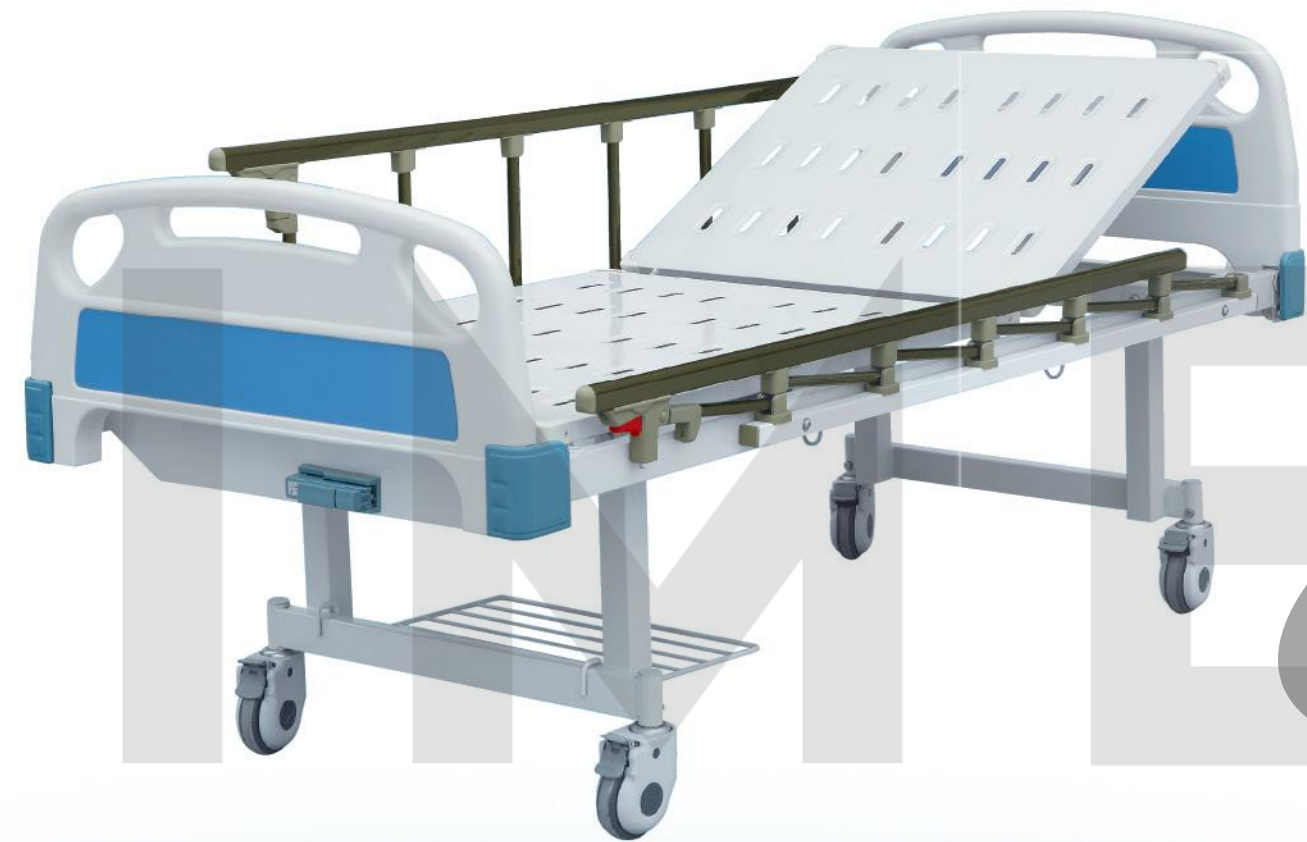

BS-817 单摇护理床
Hospital Bed with One Revolving Levers



规格:
2120*970*530mm

- 标准配置:**
- 手动摇杆弹簧拉力系统
 - 铝合金护栏一对
 - 四轮采用125mm全制动脚轮
 - 点滴架插孔每侧三个, 引流挂钩每侧二个, 输液杆一支

功能:
• 背部角度 0-80°(±5°)

可选配:
• 床垫; 餐桌;

Specifications:
2120*970*530mm

- Standard Configuration:**
- Manual crank spring tensioning system
 - Aluminium alloy folding side rails
 - 125mm dia.Noiseless castors with brake
 - Urine hooks,I.V drip

Function:
• Back-rest lifting angle is 0-80°(±5°)

Optional configuration:
• Mattress,Mobile food table



BS-818A

(86) 186-8880-7020

规格:
床体尺寸:2070*900*530mm

- 标准配置:**
- 手动摇杆弹簧拉力系统
 - 四轮采用125mm全制动脚轮
 - 点滴架插孔每侧三个, 引流挂钩每侧二个, 输液杆一支

功能:
• 背部角度 0-80°(±5°)

可选配:
• 床垫; 餐桌; 铝合金护栏

Specifications:
Overall size:2070*900*530mm

- Standard Configuration:**
- Manual crank spring tensioning system
 - 125mm dia.Noiseless castors with brake
 - Urine hooks,I.V drip

Function:
• Back-rest lifting angle is 0-80°(±5°)

Optional configuration:
• Mattress,Mobile food table
• Aluminium alloy folding side rails



BS-817A

BS-816 单摇护理床
Hospital Bed with One Revolving Levers  



BS-808 ABS平板护理床
Flat Bed



+ (86) 186-8880-7020

规格:
2070*900*530mm

标准配置:

- 手动摇杆弹簧拉力系统
- 四轮采用125mm全制动脚轮
- 点滴架插孔每侧三个, 引流挂钩每侧二个, 输液杆一支

功能:

- 背部角度 0-80°(±5°)

可选配:

- 床垫; 餐桌; 铝合金护栏

Specifications:
2070*900*530mm

Standard Configuration:

- Manual crank spring tensioning system
- 125mm dia.Noiseless castors with brake
- Urine hooks,I.V drip

Function:

- Back-rest lifting angle is 0-80°(±5°)

Optional configuration:

- Mattress,Mobile food table
- Aluminium alloy folding side rails

规格:
2120*970*530mm

标准配置:

- 点滴架插孔每侧三个, 引流挂钩每侧二个, 输液杆一支

可选配:

- 床垫; 餐桌;

Specifications:
2120*970*530mm

Standard Configuration:

- Urine hooks,I.V drip,debris racks

Optional configuration:

- Mattress,Mobile food table



BS-808A

BS-728A 二摇护理床
Hospital Bed with Two Revolving Levers



BS-728 二摇护理床
Hospital Bed with Two Revolving Levers



规格:
床体尺寸:2000*900*530mm

标准配置:

- 手动摇杆弹簧拉力系统
- 四轮采用125mm全制动脚轮
- 点滴架插孔每侧三个, 引流挂钩每侧二个, 输液杆一支

功能:

- 背部角度 0-80°(±5°)
- 膝部角度 0-40°(±5°)

可选配:

- 床垫; 餐桌;

Specifications:
Overall size:2000*900*530mm

Standard Configuration:

- Manual crank spring tensioning system
- 125mm dia.Noiseless castors with brake
- Urine hooks,I.V drip

Function:

- Back-rest lifting angle is 0-80°(±5°)
- Knee-rest lifting angle is 0-40°(±5°)

Optional configuration:

- Mattress,Mobile food table

+ (86) 186-8880-7020

规格:
床体尺寸:2000*900*530mm

标准配置:

- 手动摇杆弹簧拉力系统
- 不锈钢蚊帐架一对
- 点滴架插孔每侧二个, 引流挂钩每侧三个, 输液杆一支

功能:

- 背部角度 0-80°(±5°)
- 膝部角度 0-40°(±5°)

可选配:

- 床垫; 餐桌;

Specifications:
Overall size:2000*900*530mm

Standard Configuration:

- Manual crank spring tensioning system
- Urine hooks,I.V drip

Function:

- Back-rest lifting angle is 0-80°(±5°)
- Knee-rest lifting angle is 0-40°(±5°)

Optional configuration:

- Mattress,Mobile food table

BS-718 单摇护理床 Hospital Bed with One Revolving Levers 



规格:
床体尺寸:2000*900*530mm

标准配置:

- 手动摇杆弹簧拉力系统
- 四轮采用125mm全制动脚轮
- 点滴架插孔每侧三个, 引流挂钩每侧二个, 输液杆一支

功能:

- 背部角度 0-80°(±5°)

可选配:

- 床垫; 餐桌

Specifications:
Overall size:2000*900*530mm

Standard Configuration:

- Manual crank spring tensioning system
- 125mm dia.Noiseless castors with brake
- Urine hooks,I.V drip

Function:

- Back-rest lifting angle is 0-80°(±5°)

Optional configuration:

- Mattress,Mobile food table



BS-717A

+ (86) 186-8880-7020

BS-G838 骨科床 Orthopaedic Hospital Bed 



规格:
床体尺寸:2120*900*530/2000mm

标准配置:

- 手动摇杆弹簧拉力系统
- 铝合金护栏一对
- 四轮采用125mm全制动脚轮
- 点滴架插孔每侧三个, 引流挂钩每侧二个, 输液杆一支
- 进口304#不锈钢龙门牵引架

功能:

- 背部上升 80°
- 腿部上升 40°
- 上下升降250mm

可选配:

- 床垫; 餐桌

Specifications:
Overall size:2120*900*530/2000mm

Standard Configuration:

- Luxurious double-side silent castors
- Aluminum guardrails
- ABS head and foot board
- Imported 304#Stainless steel portal traction frame

Function:

- Back rest upward 80°
- Knee rest upward 40°
- Vertical travel 250mm

Optional configuration:

- Adjusting food table
- Mattress



BS-G738

BS-833 层流床
Laminar Flow Bed 



规格:
床体尺寸:2120*980*530mm

- 标准配置:**
- 高级电机系统 (台湾Timotion(堤摩迅) 电机一个, 电控箱一个、控制手柄一个)、风机一个
 - 铝合金护栏一对
 - 四轮采用125mm全制动脚轮
 - 点滴架插孔每侧三个, 引流挂钩每侧二个, 输液杆一支

- 可选配:**
- 床垫; 餐桌

Specifications:
2120*980*530mm

- Standard Configuration:**
- Advanced medical motor system(1 pcs motors,1 pcs draught fan ,1 pcs handset)
 - Aluminum side rail
 - Luxurious double side silent castors
 - Urine hooks,I.V drip

- Standard Configuration:**
- Mobile food table
 - Mattress

+ (86) 186-8880-7020

规格:
床体尺寸:2120*970*450/700mm

- 标准配置:**
- 高级台湾TIMOTION(堤摩迅) 电机系统 (电机三个, 电控箱一个、控制手柄一个)
 - 中控制脚刹车系统, 单触式手柄操作
 - 点滴架插孔每侧三个, 引流挂钩每侧二个, 输液杆一支

- 功能:**
- 高-低: 450mm--700mm
 - 背部角度 0-80°(±5°)
 - 膝部角度 0-40°(±5°)

- 可选配:**
- 床垫; 餐桌; 后备电源;
 - 护士操作器 (ACP)
 - 快速放倒功能 (CPR)
 - 丹麦LINAK (力纳克) 安全电压电机或台湾LINCOLN (林肯) 电机

BS-831 三功能豪华家居电动护理床
Luxurious Electric Bed with three Functions 



Specifications:
Overall size:2120*970*450/700mm

- Standard Configuration:**
- Advanced Taiwan TIMOTION medical motor system(3 pcs motors,1 pcs control box,1 pcs handset)
 - Central-controlled castor brake system
 - Urine hooks,I.V drip

- Function:**
- Height adjustable from 450 to 700mm
 - Back-rest lifting angle is 0-80°(±5°)
 - Knee-rest lifting angle is 0-40°(±5°)

- Optional configuration:**
- Mattress,Mobile food table,Back-up power system(UPS)
 - Nurse control system(ACP)
 - Quick fold down system(CPR)
 - Danmark LINAK safety voltage motor or Taiwan LINCOLN safety voltage motor



BS-830

BS-832 三功能豪华家居电动护理床
Luxurious Electric Bed with three Functions



规格:
床体尺寸:2120*970*450/700mm

标准配置:
• 高级台湾TIMOTION(堤摩迅)电机系统(电机三个,电控箱一个、控制手柄一个)
• 四轮采用125mm全制动脚轮
• 点滴架插孔每侧三个,引流挂钩每侧二个,输液杆一支

功能:
• 高-低: 450mm--700mm
• 背部角度 0-80°(±5°)
• 膝部角度 0-40°(±5°)

可选配:
• 床垫;餐桌;后备电源;
• 护士操作器(ACP)
• 快速放倒功能(CPR)
• 丹麦LINAK(力纳克)安全电压电机或台湾LINCOLN(林肯)电机

Specifications:
Overall size:2120*970*450/700mm

Standard Configuration:
• Advanced Taiwan TIMOTION medical motor system(3 pcs motors,1 pcs control box,1 pcs handset)
• 125mm dia.Noiseless castors with brake
• Urine hooks,I.V drip

Function:
• Height adjustable from 450 to 700mm
• Back-rest lifting angle is 0-80°(±5°)
• Knee-rest lifting angle is 0-40°(±5°)

Optional configuration:
• Mattress,Mobile food table,Back-up power system(UPS)
• Nurse control system(ACP)
• Quick fold down system(CPR)
• Danmark LINAK safety voltage motor or Taiwan LINCOLN safety voltage motor



+ (86) 186-8880-7020

BS-T833 三功能豪华家居电动护理床
Luxurious Electric Bed with three Functions



规格:
床体尺寸:2120*970*450/700mm

标准配置:
• 高级台湾TIMOTION(堤摩迅)电机系统(电机三个,电控箱一个、控制手柄一个)
• 四轮采用125mm全制动脚轮
• 点滴架插孔每侧三个,引流挂钩每侧二个,输液杆一支

功能:
• 高-低: 450mm--700mm
• 背部角度 0-80°(±5°)
• 膝部角度 0-40°(±5°)

可选配:
• 床垫;餐桌;后备电源;
• 护士操作器(ACP)
• 快速放倒功能(CPR)
• 丹麦LINAK(力纳克)安全电压电机或台湾LINCOLN(林肯)电机

Specifications:
Overall size:2120*970*450/700mm

Standard Configuration:
• Advanced Taiwan TIMOTION medical motor system(3 pcs motors,1 pcs control box,1 pcs handset)
• 125mm dia.Noiseless castors with brake
• Urine hooks,I.V drip

Function:
• Height adjustable from 450 to 700mm
• Back-rest lifting angle is 0-80°(±5°)
• Knee-rest lifting angle is 0-40°(±5°)

Optional configuration:
• Mattress,Mobile food table,Back-up power system(UPS)
• Nurse control system(ACP)
• Quick fold down system(CPR)
• Danmark LINAK safety voltage motor or Taiwan LINCOLN safety voltage motor

BS-815 单摇婴儿床
Children Bed with one Revolving Levers



规格:
床体尺寸:2000*860*1106mm

标准配置:

- 手动摇杆弹簧拉力系统
- 钢喷塑护栏一对
- 不锈钢蚊帐架一对
- 点滴架插孔每侧二个,引流挂钩每侧二个,输液杆一支

功能:

- 背部角度0-80° (±5°)

可选配:

- 床垫;餐桌

Specifications:

Overall size:2000*860*1106mm

Standard Configuration:

- Manual crank spring tensioning system
- Steel spray side rail,1 pair
- Stainless steel mosquito net frame,1pair
- Urine hooks,I,V drip

Function:

- Back-rest lifting angle is 0-80° (±5°)

Optional configuration:

- Mattress,Mobile food table

+ (86) 186-8880-7020



BS-612 不锈钢婴儿床
Stainless Steel Baby Bed
规格: 800*600*850mm
材质: 不锈钢+亚克力婴儿盆
Overall size:800*600*850mm
Material:Stainless steel+acrylic baby basin



BS-615 不锈钢婴儿床
Stainless Steel Baby Bed
规格: 800*460*950mm
材质: 全不锈钢
Overall size:800*460*950mm
Material:Stainless steel



BS-813 高栏儿童床
High Hurdle Steel Spray Baby Bed
规格: 2000*900*550mm
材质: 钢喷
Overall size:2000*900*550mm
Material:Steel Spray



BS-814 气缸倾斜升降婴儿推车
Air spring tilting up/down baby trolley

BS-3001 手动豪华升降抢救车
Luxurious Manual Up/Down Emergency Trolley



规格:
1950*640*500/900mm
包装尺寸: 1920*700*560mm
重量: 90KG

标准配置:
双向到位保护螺杆; 欧式豪华两折隐藏式护栏; 中控脚轮刹车系统;
背部气弹簧升降ABS床面板; 氧气瓶架; 输液架插孔; 不锈钢输液架

Specifications:
1950*640*500/900mm
Packing Size:1920*700*560mm
N.W:90KG

Configuration:
Double protection screw system,Luxurious two-fold guardrails,central-
controlled castor brake system,backrest adjustable by gas spring,ABS bed
board,oxygen cart holder,I.V.drip

BS-3002 手术对接车
Connecting Transfer Stretcher For Operation Room



规格:
3650*640*640/970mm

标准配置:
配PP护栏、输液架

说明:
对接车主要结构采用优质铝材一次压铸成型。对接轨道采用高强度铝合金型材在床面运动过程中更平稳可靠。两单体可升降调节,达到同一水平,使车架可稳定滑移。床架滑移至某一单体上可自动锁紧。两单体均采用先进的中控制车系统,在运动对接时更稳定可靠。对接车性能结构达到国际先进水平,能满足各医院手术室的需求,达到防治交叉感染的目的,是手术室理想的选择。

Specifications:
3650*640*640/970mm

Configuration:
PP side rail,I.V Drip

Introduction:
Two separate small carts can be raised and lowered for adjustment. Only when the two small carts are adjusted to the same level,the bed rest can be slid smoothly.As the bed slides to any separate small carts in order to make them smoother and more stable when linking up and running.The hand-over cart reaches international advanced level in the performance and design and can prevent cross infection so as to satisfy the needs of operation rooms in various hospitals,for which it is an ideal choice.

+ (86) 186-8880-7020

BS-3008 液压手术床
Hydraulic Integrated Operation Bed



规格:

台面长度/宽度: 2000mm/500mm
台面最低/最高高度: 780mm/1020mm
台面前倾/后倾角度: 22°/22°
台面左倾/右倾角度: 18°/18°
头板上折/下折角度: 45°/70°
腿板下折: 15°/90°
背板上折/下折角度: 75°/15°
腰桥升距: 120mm

标准配置:

- 1 麻醉屏架
- 2 肩托
- 2 腰托
- 2 搁手板
- 2 托腿架
- 2 足板

Specification:

Length/width: 2000mm/500mm
Elevation(up/down): 780mm/1020mm
Trendelenburg 22°
Reverse Trendelenburg 22°
Lateral Tilt 18°/18°
Head rest(up/down) 45°/70°
Leg Plate(up/down) 15°/90°
Back Plate(up/down) 75°/15°
Kidney bridge elevation: 120mm

Configuration:

- 1 Anaesthetic Screen
- 2 Shoulder Rest
- 2 Arm Support
- 2 Body Support
- 2 Knee Crutch
- 1 Mattress

BS-3004 电动手术床
Electric Operation Bed



规格:

台面长度/宽度: 2000mm/500mm
台面最低/最高高度: 680mm/930mm
台面前倾/后倾角度: 25°/25°
台面左倾/右倾角度: 20°/20°
头板上折/下折角度: 45°/90°
腿板下折/外折角度/上折: 90°/90°/15°
背板上折/下折角度: 75°/10°
腰桥升距: 120mm
平移: 300mm
电源电压、电源频率、电源容量: 220V, 50Hz, 1.0kW

标准配置:

- 1 麻醉屏架
- 2 肩托
- 2 腰托
- 2 搁手板
- 2 托腿架
- 2 足板

Specification

Length/Width: 2000mm/500mm
Elevation(up/down): 680mm/930mm
Trendelenburg: ≥25°
Reverse Trendelenburg: ≥25°
Lateral Tilt(left/right): 20°/20°
Head Rest(up/down): 45°/90°
Footplate(up/down&horizontal positioning): 90°/90°/15°
Back plate(up/down): 75°/10°
Kidney bridge: 120mm
Sliding: 300mm
Power: 220v, 50Hz, 1.0kW

Configuration:

- 1 Anaesthetic Screen
- 2 Shoulder Rest
- 2 Arm Support
- 2 Body Support
- 2 Knee Crutch
- 1 Mattress

+ (86) 186-8880-7020



BS-601 急诊车
Emergency Trolley

规格:1900*630*800mm

标准配置:

- 铝合金护栏
- 不锈钢可移动担架
- 5寸轮带刹
- 可移动床垫

Size:1900*630*800mm

Standard accessory:

- Aluminum side rails.
- Stainless steel removable stretcher.
- 5" silent castors with 2 skids.
- Removable Mattress



BS-602 小四轮担架车
Stainless steel stretcher with Four Castors

规格:1900*630*800mm

标准配置:

- 不锈钢护栏
- 不锈钢可移动担架
- 5寸轮带刹
- 可移动床垫

Size:1900*630*800mm

Standard accessory:

- Stainless steel side rails.
- Stainless steel removable stretcher.
- 5" silent castors with 2 skids.
- Removable Mattress
- Shelf



BS-773A 不锈钢妇科床
Gynecological Examining Table

规格:1300+600*650*800mm

材料:不锈钢+皮革

Specification:1300+600*650*800mm

Material:Stainless Steel and sponge and PU



BS-776 电动按摩床
Electric Massage Tables

规格:1900*620*490/780mm

功能:高度可调490-780mm

Specification:1900*620*490/780mm

Function:Height adjustable from 490mm to 780mm



BS-603 病人推车
Trolley for Patient

规格:1900*630*800mm

材料:不锈钢, 皮革

Size:1900*630*800mm

Material: Stainless steel



BS-604 病人推车
Trolley for Patient

规格:1900*570*380mm

材料:全不锈钢

标准配置:医用静音脚轮四个

Size:1900*570*380mm

Material:Stainless steel

Standard accessory:Medical mute casters four PCS



BS-775B 诊查床
Examination Bed

规格:1900*650*650mm

材料:不锈钢+皮革

功能:背部可调 70°±5°

Specification:1900*650*650mm

Material:Stainless Steel and sponge and PU

Function:Back tilt 70°±5°



BS-775 诊查床
Examination Bed

规格:1900*650*650mm

材质:不锈钢+皮革

功能:背部倾斜70°

Material:Stainless Steel and

sponge and PUFuction:Back rest up 70°±5°

+ (86) 186-8880-7020

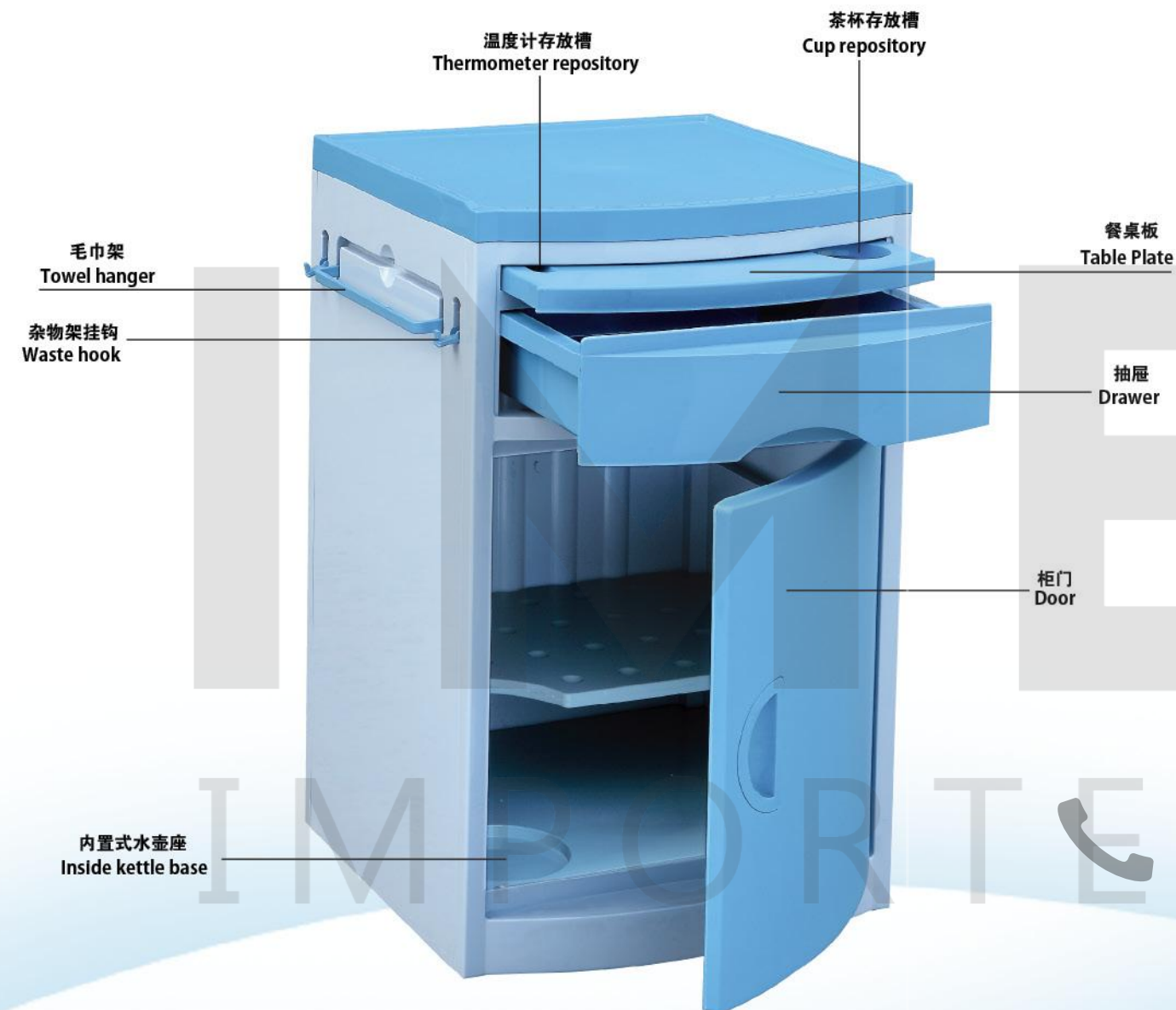

BS-513 床头柜
Bedstand
Size:480*480*760mm



BS-514 床头柜
Bedstand
Size:480*470*790mm



BS-515 床头柜
Bedstand
Size:480*470*870mm



BS-516 床头柜
Bedstand
Size:500*500*700mm



BS-517 床头柜
Bedstand
Size:440*470*770mm



BS-518 床头柜
Bedstand
Size:470*470*780mm



BS-519 床头柜
Bedstand
Size:480*400*810mm



BS-520 床头柜
Bedstand
Size:450*420*800mm



BS-521 床头柜
Bedstand
Size:450*420+170*800mm



BS-522 床头柜
Bedstand
Size:450*420*800+100mm

+ (86) 186-8880-7020



BS-581 感应洗手槽
Inductive Hand Wash Sink
Size:1600*580*900+360mm



BS-582 304#不锈钢感应洗手槽
304#Stainless Steel Inductive Hand Wash Sink
Size:1600*600*900+360mm



BS-583 304#不锈钢清洗盆台柜
304#Stainless Steel Cabinet of Wash Sink
Size:1900*600*800+150mm



BS-585 304#不锈钢洗手槽
304#Stainless Steel Wash Sink
Size:340*360*750mm



BS-560 不锈钢地柜
Stainless Steel Ground Ark
Size:1900*500*900mm



BS-561 不锈钢水剂调配柜
Stainless Steel Prepare Cabinet
Size:1200*300/600*1980mm



BS-562 不锈钢双面西药调剂柜
Stainless Steel Double Face Distributor Store Cabinet
Size:1980*300/1000*1980mm

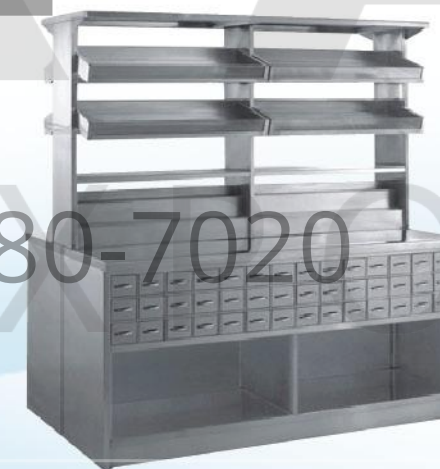

BS-563 不锈钢地柜
Stainless Steel Ground Ark
Size:1900*500*900mm



BS-565 不锈钢立式中药柜
Stainless Steel Chinese Herb Medical Cabinet
Size:980*400*1980mm



BS-566 不锈钢双面中药柜
Stainless Steel Double Face Chinese Herb Medical Cabinet
Size:1980*500/1200*1980mm

+ (86) 186-8880-7020



BS-576 不锈钢成药架
Stainless Steel Medicine Shelf
Size:980*400*1980mm



BS-579 不锈钢无门药柜
Stainless Steel Medicine Shelf
Size:980*400*1980mm



BS-577 不锈钢器械柜
Stainless Steel Cupboard
Size:1200*650*1800mm



BS-620 急救车
ABS Emergency Trolley
Size:850*520*950mm/750*475*920mm



BS-621 麻醉车
ABS Anesthesia Trolley ABS
Size:630*470*920mm/673*480*920mm



BS-623 治疗车
ABS Clinical Trolley ABS
Size:650*475*920mm



BS-625 送药车
ABS Medicine Trolley ABS
Size:790*480*920mm



BS-570 不锈钢器械柜
Stainless Steel Cupboard
Size:900*400*1750



BS-571 不锈钢器械柜
Stainless Steel Cupboard
Size:900*400*1750



BS-572 钢制喷塑文件柜
Powder-coating File Cabinets
Size:900*400*1750mm



BS-652 ABS病例车
ABS Case history trolley
Size:640*410*950mm



BS-650 ABS病例车
ABS Case history trolley
Size:410*410*970mm



BS-655 钢塑多功能推车
Steel-Plastic Luxury Trolley
Size:600*410*900mm



BS-660 实用型多功能推车
Utility Trolley
Size:539*366*950mm

+ (86) 186-8880-7020



BS-631 不锈钢三层仪器车
Stainless Steel Instrument Trolley
Size:680*420*800mm



BS-635 不锈钢扇形器械车
Stainless Steel Instrument Trolley
Size:1220*460*800mm



BS-632 不锈钢双层器械车
Stainless Steel Instrument Trolley



BS-658 不锈钢抢救车
Stainless Steel Emergency Cart
Size:650*420*870mm



BS-662 不锈钢清创车
Stainless Steel Clean Wound Cart
Size:750*450*800mm



BS-664 不锈钢带暖瓶架送水车
Stainless Steel Cart with Thermos Bottle Holders
Size:870*544*900mm



BS-631B 304#不锈钢三层器械车 (镜面)
304#Stainless Steel Instrument Trolley(mirror surface)
Size:550*840*750mm



BS-632B 304#S不锈钢双层器械车 (镜面)
304#Stainless Steel Instrument Trolley(Mirror Face)
Size:550*840*750mm



BS-636 不锈钢单抽治疗车
Stainless Steel Treatment Cart
Size:640*420*800mm



BS-665 不锈钢平板推车
Stainless Steel Flat Trolley
Size:800*500*200+600mm



BS-667 不锈钢升降式盘架
Stainless steel lifting rack
Size:595*395*895/1420mm



BS-673 不锈钢氧气瓶推车
Stainless Steel Oxygen Cylinder Cart

+ (86) 186-8880-7020



BS-668 不锈钢铺床护理车
Stainless Steel Trolley for Making Up Bed
Size:900*480*975mm



BS-670 不锈钢污衣车
Stainless Steel Trolley for Dirty Clothes
Size:450*500*850mm



BS-679A 不锈钢三角输液架
Stainless Steel I.V Stand with 3 Wheels



BS-679B 塑料五星脚输液架
I.V Stand with 5 Plastic Wheels



BS-679C 塑料五星脚输液架
I.V Stand with 5 Plastic Wheels



BS-680A 输液杆
I.V Drip



BS-680B 输液杆
I.V Drip



BS-674 不锈钢屏风
Size:500*1800mm each section(Including 3、4 or 5 Sections)
Material:Imported macromolecule compounded material, anti-bacteria
规格:每折500*1800mm(可分3、4、5折)
材料:不锈钢, 医用棉质布

+(86) 186-8880-7020



BS-G06-1 液压移动餐桌
Luxurious hydraulic Over-bed Table



BS-G06-2 液压移动餐桌
Luxurious hydraulic Over-bed Table



BS-G202 可旋式升降餐台
Revolving Over-bed Table



BS-G203 简易升降餐台
Simple Over-bed Table



BS-G204 简易升降餐台
Simple Over Bed Table



BS-213 输液椅
Infusion Chair



BS-214 输液椅
Infusion Chair



BS-212 输液椅
Infusion Chair



BS-210 候诊椅
waiting-room bench



BS-211 候诊椅
waiting-room bench



BS-008 不锈钢脚踏凳
Stainless Steel Foot Stool



BS-008-1 不锈钢脚踏凳
Stainless Steel Foot Stool



BS-216 陪人椅
accompanying chairs



BS-675A 不锈钢手术圆凳
Stainless Steel Operation Stool



BS-675C 带靠背手术圆凳
Operation Stool with Backrest



BS-675E 带靠背手术圆凳
Operation Stool with Backrest



BS-675B 塑料凳面手术圆凳
Plastic Seat Cover Operation Stool



BS-675D 带靠背手术圆凳
Operation Stool with Backrest



BS-675F 带靠背手术圆凳
Operation Stool with Backrest



BS-1A3 铝合金折叠担架
Aluminum Alloy Foldable Stretcher
展开尺寸 (长*宽*高) 185*50*24cm
折叠尺寸 (长*宽*高) 92*50*11cm
Product size (L*W*H): 185* 50*24cm
Folded size (L*W*H): 92*50*11cm



BS-1A3 铝合金折叠担架
Aluminum Alloy Foldable Stretcher
展开尺寸 (长*宽*高) 185*50*24cm
折叠尺寸 (长*宽*高) 92*50*11cm
Product size (L*W*H): 185* 50*24cm
Folded size (L*W*H): 92*50*11cm



BS-1B3 折叠担架 (钢)
Epoxy Coated Steel Foldable Stretcher
展开尺寸 (长*宽*高) 185*50*3cm
折叠尺寸 (长*宽*高) 92.5*50*10cm
Product Size:1850*500*30mm(L*W*H)
Folded Size:925*500*100mm(L*W*H)



BS-3A 铝合金救护车担架
Automatic Loading Stretcher for Ambulance Car (P40)
最高位: 190*55*92cm
最低位: 190*55*26cm
Product Size (L x W x H): High position: 190 x 55 x 92cm;
Low position: 190 x 55 x 26cm



BS-1F3 铝合金折叠担架
Aluminum Alloy Foldable Stretcher
展开尺寸 (长*宽*高) 208*55*13cm
折叠尺寸 (长*宽*高) 104*17*9cm
Product Size:208*54.5*13cm(L*W*H)
Folded Size:104 x 17 x 9cm(L*W*H)



BS-218-1 床垫
Mattress

规格: 可根据需方要求制作
材质: 防水、防霉、透气布套、海绵、椰棕
高密度棕片、高密度弹性海绵
防水布: 液体不渗透表层擦拭容易, 可长期保持创百干净卫生, 有透气性
Thickness:80mm
Material:Waterproof, mofstureproof, ventilate cover, sponge, palm fiber



BS-218-2 床垫
Mattress

规格: 可根据需方要求制作
材质: 防水、防霉、透气PVC软套、海绵、椰棕、高密度棕片、高密度弹性海绵
Thickness:80mm
Material:Waterproof, moistureproof, PVC soft cover, ventilate cover, sponge, palm fiber



BS-218-2 Alternating Pressure Mattress

Technical Parameters:
★ Technical Parameters of The Mattress
1. Dimensions(LxWxH): 180x80x7.5cm
2. Cell Height: 7.5cm/3"
3. Cell and base material: Nylon + PVC
4. Material thickness: ≥0.35mm
5. Number of cells: 24 + 1 spare cell
6. Number of cells with holes: 10 (2 holes for 1 cell)
7. Weight support: 110kg

★ Technical Parameters of The Pump
1. Electric: AC 110V/AC 220V
2. Pressure range: 50-110 mmHg
3. Air Output: 5-8 liter/min
4. Cycle time: 6 min
5. Dimensions(LxWxH): 25x13x9.5cm
6. Weight: 1.6 kg

+ (86) 186-8880-7020



BS-7001 可折轮椅(全电镀脚踏板)
Detachable Wheelchair
钢管车架、固定扶手、固定脚、车架电镀、PVC座椅垫、8寸塑胶前轮、24寸钢丝后轮
Description:
Steel tube frame , fixed armrest , fixed foot frame plating , PVC seat cushions 8 inch plastic front wheel , 24 inch wire rear wheel



BS-7002 可折轮椅(全喷塑,胶踏板)
Detachable Wheelchair
钢管车架、固定扶手、固定脚、车架喷涂、格子布座背垫、8寸塑胶前轮、24寸钢丝后轮、塑胶踏板、塑胶手扶圈
Description:
Steel frame, fixed armrest, fixed foot, frame spray, checkered cloth seat back cushion, 8 inch plastic front wheel, 24 inch wire rear wheels, plastic pedals, plastic hand ring.



BS-7003 可折轮椅
Folding Wheel Chair
钢管车架、可拆扶手、可拆脚、电镀车架、PVC座垫、8寸塑胶前轮、24寸钢丝后轮
Description:
Steel tube frame, detachable armrest, detachable feet, plating frame, PVC seat back cushion, 8 inch plastic front wheel, 24 inch wire rear wheel.



BS-7005 可折轮椅
Folding Wheel Chair
钢管车架、固定扶手、可拆脚、带手刹、折叠靠背、车架喷涂、格子布座背垫、8寸塑胶前轮、22寸PU塑胶后轮、塑胶踏板、配安全带。
Description:
Steel tube frame, fixed armrest, detachable feet, with a hand brake, folding rely on Back, frame spraying, checkered cloth seat back cushion, 8 inch plastic front wheel, 22 inch plastic rear wheels, plastic pedals with safety belts.



BS-7004 高靠背轮椅
High Back Wheel Chair
钢管车架、可拆扶手、可拆升降脚、高靠背可躺平躺、车架电镀、PVC座背垫、8寸PU塑胶前轮、24寸钢丝后轮
Description:
Steel tube frame, detachable armrests, detachable lift feet, high back, adjustable flat, frame plating, PVC seat back cushion, 8 inch PU plastic front wheel, 24 inch steel wire rear wheel



BS-7006 座便轮椅
Commode Wheelchair
钢管车架、固定扶手、固定脚、电镀车架、PVC座背软垫、8寸塑胶前轮、24寸钢丝后轮、拉板式座便轮椅
Description:
Steel tube frame, fixed armrest, fixed foot, plating frame, PVC seat back cushion, 8 inch plastic front wheel, 24 inch wire rear wheel, pull the plate toilet wheelchair

+ (86) 186-8880-7007

规格cm 型号														CNTS 20' FCL	CNTS 40' FCL
BS-7001	64	24	44	60	20	48	86	100	40	40	100	94X24X88	18/19	144	300
BS-7002	64	24	44	60	20	48	86	100	40	40	100	94X24X86	18/19	144	300
BS-7003	64	24	44	60	20	48	86	102	40	40	100	94X24X86	18/19	184	350

规格cm 型号														CNTS 20' FCL	CNTS 40' FCL
BS-7004	64	28	45	60	20	51	120	120	40	78	100	94X29X91	28/30	96	186
BS-7005	60	29	42	56	20	48	89	105	40	40	100	78X29X70	13.5/55	170	350
BS-7003	64	24	45	60	20	49	86	100	44	41	100	94X25X86	19/20	130	260



BS-592 6'' 铝合金助行车
6'' Aluminum Rollator



BS-593 8'' 铝合金助行车
8'' Aluminum Rollator



BS-594 马桶椅
Steel Folding Commode



BS-595 铝制马桶椅
Aluminum 3-1 N-1 Commode Chair



BS-596 电镀马桶椅
Electroplate Commode Chair



BS-597 铝制马桶椅
Aluminum Commode Chair



BS-598 U型洗澡椅
U Shape Shower Bench



BS-599 铝质洗澡椅
Aluminum Shower Chair



BS-600 三片式洗澡椅
Aluminum Transfer Bench



BS-A01 BS-A02 BS-A03 BS-A04 BS-A05 BS-A06 BS-A07



BS-A08 BS-A09 BS-A10 BS-A11 BS-A12 BS-A13 BS-A14 BS-A15 BS-A16

+ (86) 186-8880-7020

型号 Model No	高 Height	箱规 Meas	支/箱 Packing	最大载重 Load Capacity	净重/毛重 N.W/G.W	20英尺装柜量 CNTS 20FCL	40英尺装柜量 CNTS 40HQ
BS-A01	67.5-90	66*17*19	20	100	0.3/7.5	18080	42120
BS-A02	67.5-90	66*13*29	20	100	0.3/7.5	23680	55080
BS-A03	67.5-90	66*17*29	20	100	0.3/7.5	18080	42120
BS-A04	77-100	66*17*29	20	100	0.3/7.5	18080	42120
BS-A05	67.5-90	66*17*29	20	100	0.3/7.5	18080	42120
BS-A06	79.5-87	66*17*29	20	100	0.34/8.3	18080	42120
BS-A07	79.5-87	66*17*29	20	100	0.34/8.3	18080	42120
BS-A08	75-98	100*30*30	20	100	0.52/11.9	5460	13280
BS-A09	75-98	100*30*30	20	100	0.52/11.9	5460	13280
BS-A10	75-98	100*30*30	20	100	0.52/11.9	5460	13280
BS-A11	75-98	100*30*30	20	100	0.52/11.9	5460	13280
BS-A12	94-120	90*30*30	20	100	0.58/13.1	6160	14560
BS-A13	104-134	95*30*30	20	100	0.66/14.7	5880	13760
BS-A14	94-124	88*30*30	20	100	0.64/14.3	6160	14880
BS-A15	84-114	85*30*30	20	100	0.62/13.9	6440	15680
BS-A16	64-91	64*30*30	20	100	0.54/12.3	8820	20640



+ (86) 186-8880-7020

型号 Model No	高 Height	箱规 Meas	支/箱 Packing	最大载重 Load Capacity	净重/毛重 N.W./G.W	20英尺装柜量 CNTS 20FCL	40英尺装柜量 CNTS 40HQ
BS-A17	73-96	73-96	10	100	0.95/11	2450	6000
BS-A18	72-94.5	72-94.5	10	100	0.92/10.7	2450	6000
BS-A19	84.5	86*30*41	20	100	0.84/9.9	2300	5700
BS-A20	119	53*13*26	20	100	0.18/5.1	31680	75600
BS-A21	95-126	86*27*30	20	100	0.56/12.7	7280	17280
BS-A22	87-117	96*30*30	20	100	0.5/11.5	5880	13760
BS-A23	134.5-154	140*33*29	20	100	0.9/10.5	4480	10440
BS-A24	113-133	120*33*29	20	100	0.78/9.3	4960	11880
BS-A25	84-114	101*33*29	20	100	0.8/9.5	6240	14580
BS-A26	132-152	137*33*29	20	100	0.8/9.5	4640	10620
BS-A27	112-133	117*33*29	20	100	0.76/9.1	5600	12600
BS-A28	91-111	99*33*29	20	100	0.7/8.5	6240	15120
BS-A29	100-151	120*33*27	20	100	0.8/9.5	4960	11880

版本: 2013

ABS 病床系列

"Let us help to build your dreams"



KS-838f ICU三立柱电动床
Multifunctional electric hospital bed
L2150×W1150×H590-840mm
包装:2100×1100×640mm



KS-838f-3 豪华五功能二立柱电动床
Deluxe electric five-function care bed
L2150×W1030×H520-720mm
包装:2100×1000×580mm



KS-838e 豪华五功能称量电动床
Deluxe electric five-function Weighing care bed
L2150×W1080×H500-780mm
包装:2100×1000×580mm



KS-838a 五功能电动床
Deluxe electric five-function care bed type B
L2150×W1080×H450-740mm
包装:2100×1100×500mm



KS-838b 五功能电动床 (无护栏控制器)
Deluxe electric five-function care bed type B
2120×1080×450-740mm
包装:2100×1100×500mm



KS-838 五功能电动床(含CPR)
Deluxe electric five-function care bed type B
L2120×W1030×H450-740mm
包装:2100×1000×500mm



KS-838c X光青板五功能电动床
Deluxe electric five-function care bed type B
L2120×W1030×H450-740mm
包装:2100×1000×500mm



KS-858 五功能电动床
High-class Electric Five-function Care Bed
L2120×W1030×H450-740mm
包装:2100×1020×500mm



KS-858b-3 五功能电动床 (豪华轮)
Function care bed (Deluxe castor)
L2150×W970×H450-740mm
包装:2100×960×500mm



KS-858-3 五功能电动床
Electric five-function care bed
L2150×W1030×H450-740mm
包装:2100×1000×500mm



KS-828b 三功能电动床(有轮连接)
Electric three-function care bed
L2120×W1030×H450-740mm
包装:2100×1000×500mm



KS-828c 三功能电动床(无轮连接)
Electric Three-function Care Bed
L2120×W1030×H450-740mm
包装:2100×1000×500mm



KS-828d-3 三功能中控电动床
Electric Three-function central lock care bed
L2150×W970×H450-740mm
包装:2100×960×500mm



KS-828e-3 三功能电动床(豪华轮)
Electric Three-function care bed
L2150×W970×H450-740mm
包装:2100×960×500mm



KS-803-5 电动五功能中控翻身床
Electric Five-function central lock rolling care bed
L2200×W970×H580-800mm
包装:2100×960×640mm



KS-1032-3 ABS手动四摇翻身床
 ABS Manual Four-crank Rolling Care Bed
 L2200×W970×H580-800mm
 包装:2100×960×640mm



KS-1033 ABS手动三摇翻身床
 ABS Manual Three-crank Rolling Care Bed
 L2200×W970×H580mm
 包装:2100×960×640mm



KS-888-3 三功能电动超低床
 Deluxe Electric Three-function Super Low Care Bed
 L2150×W970×H210mm-580mm
 包装:2100×960×390mm



KS-818a-3 二功能电动床(带中控)
 Electric two-function care bed
 L2150×W1030×H485mm
 包装:2100×1000×400mm



KS-818 二功能电动床
 Electric Two function Care Bed
 L2120×W970×H485mm
 包装:2100×960×320mm



KS-828k 三功能电动血透床 (日款)
 Electric Three-function Care Bed(ICU Unit)
 L2120×W800×H450-740mm
 包装:2100×960×500mm

骨科护理病床系列



KS-555 四摇骨科护理床(配双龙门架)
 European Design Four-crank Rolling Care Bed(Double Traction)
 L2150×W970×H450-740/1850mm
 包装:2050×960×500mm



KS-555-3 手动四摇骨科护理床(配双龙门架)
 Manual four-crank orthopedic care bed (Double traction)
 L2150×W970×H450-740/1850mm
 包装:2100×960×640mm



KS-554-3 骨科护理床(配双龙门架)
 ABS Four-crank Orthopedics Speciality Bed (Double traction)
 L2150×W970×H485/1850mm
 包装:2100×960×640mm

+ (86) 186-8880-7020

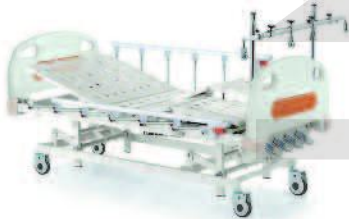

KS-536-3 四摇骨科护理床(配单龙门架)
 Four-crank Orthopedics Speciality Bed (Single Traction Frame)
 L2150×W970×H450-740mm
 包装:2100×960×640mm



KS-553-3 三摇骨科护理床(配单龙门架)
 Three-crank Orthopedics Speciality Bed (Single Traction Frame)
 L2150×W970×H485mm
 包装:2100×960×350mm



KS-558-3 三摇骨科护理床(配双龙门架)
 Three-crank Orthopedics Speciality Bed (Double Traction)
 L2150×W970×H485/1850mm
 包装:2100×960×450mm

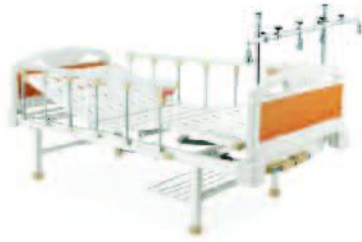

KS-552 欧式双摇骨科护理床(配单龙门架)
 European Design ABS Two-orthopedic Speciality Bed(Single Traction Frame)
 L2150×W970×H485mm
 包装:2100×960×320mm



KS-532 ABS二摇骨科床(双龙门架)
 ABS Two-orthopedic Manual Care Bed
 L2120×W970×H485mm
 包装:2100×960×350mm



KS-533 ABS三摇骨科床(双龙门架)
 ABS three-orthopedic Manual Care Bed
 L2120×W970×H485/1850mm
 包装:2100×960×350mm



KS-535 ABS三摇骨科床(单龙门架)
 ABS three-orthopedic Manual Care Bed
 L2120×W970×H485mm
 包装:2100×960×320mm



KS-534 ABS四摇骨科床
 ABS Four-orthopedic Manual Care Bed
 L2120×W970×H485/1850mm
 包装:2100×960×450mm



KS-538 (原KS-534a) ABS四摇骨科床(单龙门架、可倾斜)
 ABS Four-orthopedic Manual Care Bed
 L2120×W970×H485 mm
 包装:2100×960×450mm

家居护理床系列



KS-888b 三功能电动家居超低位床
 Electric Three-function Super Low Home Care Bed
 L2080×W970×H210~580mm
 包装: 2040×940×250 mm



KS-898 电动超低位床
 Electric Three-function Super Low Care Bed (ICU Unit)
 L2120×W970×H250~580mm(含护栏)
 包装: 2040×940×280 mm

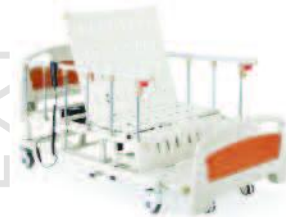

KS-836 四功能电动床90°座椅床
 Electric 90° Seating Bed
 L2120×W870×H500~780mm
 包装: 1920×1050×550 mm



KS-806 三功能电动家居床
 Three-Functions Electric Home Care Bed
 L2090×W1200×H350~630mm
 包装: 2000×1200×400床架
 包装: 1260×1260×160木柜



KS-828h三功能电动家居床
 Electric Three-function Home Care Bed
 L2090×W1200×H450mm~740mm
 包装: 2050×1180×500mm



KS-342a 手动双摇家居床
 Manual Two-orthopedic Home Care Bed
 L2090×W970×H485mm
 包装: 2050×920×280mm



KS-442 ABS日式双摇电床
 Three Function Electrical Care Bed
 L2120×W800×H485mm
 包装: 2040×840×230 mm



KS-332 ABS手动双摇护理床(豪华轮)
 Manual Two-orthopedic Care Bed
 L2120×W970×H485mm
 包装: 2040×840×230 mm



KS-333 (原KS-332a) 手动双摇护理床
 Manual Two-orthopedic Bed Without Casters
 L2120×W970×H485mm
 Packing: 2040×840×230 mm



KS-338(原KS-332c) ABS中控双摇床
 ABS Double-krank Manual Care Bed
 L2120×W970×H485mm
 包装:2040×940×360mm



KS-232 ABS手动单摇护理床(豪华轮)
 Manual One-krank Care Bed
 L2120×W970×H486mm
 包装: 2040×940×230mm



KS-233(原KS-232a) ABS手动单摇护理床
 Manual One-krank Care Bed Without Castors
 L2120×W970×H485mm
 包装: 2040×940×230mm



KS-130 平板护理床
 Deluxe Flat Care Bed
 L2120×W970×H485mm
 包装: 2040×920×170mm



KS-828j 三功能电动中控家居床
 Electric Three-function Home Care Bed
 L2080 × W870 × H450 - 740mm
 包装: 2040×940×480mm



KS-828g-3 三功能中控家居床(中控轮)
 Electric three-function central lock home care bed
 L2070×W1030×H450-740mm
 包装:2100×1100×640mm



KS-828g-5 三功能电动家居床(豪华轮)
 Electric three-function central lock home care bed
 L2070×W1030×H450-740mm
 包装:2100×1000×400mm



KS-818-1 二功能中控电动家居床
 Electric Two-function central lock home care bed
 规格: L2000×W1200×H460mm
 包装:2050×1180×500mm



KS-803-2 五功能电动家居翻身床
 Electric Five-function rolling care bed
 L2200×W970×H580-800mm
 包装:2100×1100×840mm



KS-342-1 二功能中控手动双摇家居床
 Electric Two-function central lock home care bed
 规格: L2000×W1030×H450mm
 包装:2050×1160×500mm



KS-342-2 二功能手动双摇家居床
 Electric Two-function central lock home care bed
 规格: L2000×W1030×H450mm
 包装:2050×1180×280mm



KS-803-3 五功能电动家居翻身床
 Electric Five-function rolling care bed
 L2200×W970×H580-800mm
 包装:2100×1100×640mm



KS-632 手动三摇护理床 (豪华轮)
 Manual three-krank care bed
 L2120×W970×H450-740mm
 包装:2100×980×500mm



KS-633-3 手动三摇中控护理床
 Manual three-krank care bed
 L2150×W1030×H450-740mm
 包装:2100×980×500mm



KS-662-3 手动三摇护理床 (豪华轮)
 Manual three-krank care bed (Deluxe castors)
 L2150×W970×H450-740mm
 包装:2100×980×500mm



KS-653-3 手动中控三摇护理床
 Manual three-crank care bed
 L2150×W970×H450-740mm
 包装:2100×940×500mm



KS-652a-5 手动四摇五功能护理床
 Manual four-crank/five function care bed
 L2150×W970×H450-740mm
 包装:2100×940×500mm



KS-332-5 手动双摇护理床
 Manual Two-crank care bed
 L2150×W970×H485mm
 包装:2100×940×350mm



KS-336-5 双摇护理床(豪华轮)
 ABS European design two-crank care bed (deluxe castor)
 L2150×W970×H485mm
 包装:2100×940×500mm



KS-356-3 手动双摇中控护理床
 Manual Two-crank care bed
 L2150×W970×H485mm
 包装:2100×940×500mm



KS-130-5 平板护理床 (带护栏)
 Deluxe flat care bed
 L2150×W970×H485mm
 包装:2100×940×350mm

婴儿护理床系列



KS-432-5 手动双摇透析护理床
 Manual Two-crank Dialysis care bed
 L2150×W970×H485mm
 包装:2100×940×350mm



KS-911-2 双摇中控豪华儿童床
 Two crank luxury children care bed
 L1850×W800×H500/1260mm
 包装:1900×900×450mm



KS-911-1 双摇豪华儿童床
 Two crank luxury children care bed
 L1850×W800×H500/1260mm
 包装:1900×900×450mm

+ (86) 186-8880-7020



KS-911 栅栏式豪华单摇儿童床 (型钢)
 Deluxe Children Care Bed
 L1850×W800×H500mm/1160
 包装:1900×900×450mm



KS-914 豪华平板儿童床 (型钢)
 Deluxe Flat Children Care Bed
 L1850×W800×H500mm
 包装:1900×900×450mm



KS-915 豪华单摇儿童床 (型钢)
 Deluxe Manual One-crank Children Care Bed
 L1850×W800×H500mm
 包装:1900×900×450mm



KS-R003 ABS升降可倾婴儿床
 Two crank luxury children care bed
 L800×W500×H780-980 mm
 包装: 800×550×550mm



KS-A20 钢制豪华婴儿车
 Deluxe Baby Trolley
 L800×W480×H900 mm
 包装: 830×510×810 mm



KS-A26 钢制婴儿车
 Deluxe Baby Trolley
 L820×W620×H900 mm
 包装: 850×550×860 mm



KS-A21 全不锈钢婴儿床
 S.S. Baby Cot
 L700×W445×H900mm
 包装: 730×490×820mm



KS-A22 全不锈钢可倾斜婴儿床
 S.S. Baby Trolley (Tilting)
 L820×W500×H900 mm
 包装: 850×540×950 mm



KS-A23 钢制婴儿床
 Deluxe Baby Trolley
 L800×W480×H900 mm
 包装: 830×530×750 mm



KS-A24 钢制床上桌型婴儿床 (固定式和升降式)
 Over-bed Baby Bassinet
 L800×W480×H815~1200 mm
 包装: 870×510×730两台/包

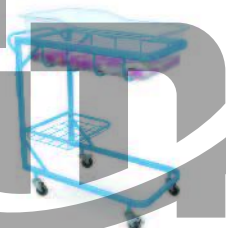

KS-A25 钢制豪华婴儿床
 Deluxe Baby Trolley
 L900×W480×H1030 mm
 包装: 1190×490×870两台/包



KS-731 全不锈钢妇科检查床
 S.S. Gynaecological Table
 L1800×W580×H750 mm
 包装: 1300×600×780 mm

妇产床系列



KS-735(原KS-733b) 全不锈钢综合妇产床
 S.S. Integrative Gynaecological Table
 L1900×W820×H750 mm
 包装: 1350/850×780×750 mm



KS-820a 电动手术台
 Electric Operation Table
 L2070×W480×H650~850 mm
 包装: 1300×870×870 mm



KS-820 电动手术台
 Electric Operation Table
 L2070×W480×H650~850 mm
 包装: 1300×870×820mm



KS-728 综合手术台
 Integrative Operation Table
 L2100×W480×H780/1020 mm
 包装: 1300×870×920mm



KS-811 电动妇科床
 Electric Gynaecological Table
 L1800×W600×H650-900 mm
 包装: 1900×900×450mm



KS-812 多功能妇产床
 Deluxe electric bed
 L2000×W850×H550-1000mm
 包装: 1900×900×450mm



KS-811a 电动妇产床
 Electric Gynecological Table
 L1900×W800×H700-950 mm
 包装: 1900×900×450mm



KS-898 电动妇科检查床
 Deluxe electric bed
 L1450×W600×H630-1000 mm
 包装: 1550×700×750mm



KS-898a 电动妇产床
 Deluxe electric bed
 L1900×W800×H700-950 mm
 包装: 2000×700×800mm



KS-734 多功能产床
 Multi-function Delivery Table
 L1750×W800×H650/850 mm
 包装: 1350×870×890 mm



KS-004a 九段拉手法床(康复用)
 Multiple Electric Bed
 L1980×W850×H450~850mm
 包装: 2010×680×480mm



KS-001 无提背诊查床
 Flat Examination Table
 L1900×W850×H850 mm
 包装: 1820×860×300两件/包



KS-002 带提背诊查床
 Examination Table With Adjustable Backrest
 L1900×W850×H850 mm
 包装: 1950×660×250两件/包



KS-005a 电动诊查床
 Electric Examination Bed
 L1900×W850×H550~800mm
 包装: 1920×660×560 mm



KS-003b 电动升降治疗床(康复用)
 Up/down Electric Treatment Bed
 L2080×W1250×H450~850mm
 包装: 2120×1280×480mm



KS-005 电动卷纸诊察床



KS-006 不锈钢诊查床
 Stainless Steel Examination Table
 L1900×W850×H650 mm
 包装: 2080×380×440两件/包

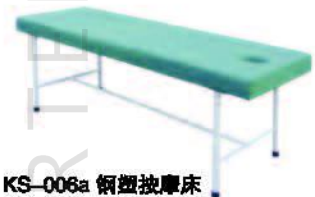

KS-006a 钢塑按摩床
 Steel Massage Bed
 L1900×W650×H650 mm
 包装: 1920×660×150 mm

不锈钢病床系列



KS-523 三摇分腿骨科牵引床(全不锈钢)
 S.S. Three-crank Orthopaedics bed
 L2000×W900×H550mm
 包装: 2120×940×230 mm



KS-524 四摇分腿可倾斜骨科牵引床(全不锈钢)
 S.S. Four-crank Orthopaedics bed
 L2000×W900×H550mm
 包装: 2120×940×450 mm



KS-910 不锈钢儿童床
 Children Care Bed
 L1880×W800×H560mm
 包装: 1840×850×190 mm

不 锈 钢 病 床 系 列

KS-612 全不锈钢三摇ICU急救床
 S.S. Manual Three-crank ICU Emergency Bed
 L2000×W900×H450~720mm
 包装: 2040×920×480 mm

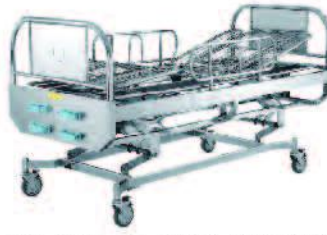

KS-1012 全不锈钢四摇翻身床
 S.S. Four-crank Rolling Bed
 L2000×W900×H580~880mm
 包装: 2040×920×600 mm



KS-312 全不锈钢两摇三折床
 S.S. Two-crank Rolling Bed
 L2000×W900×H560mm
 包装: 1980×960×140 mm



KS-322 全不锈钢两摇三折床
 S.S. Two-crank Care Bed
 L2000×W900×H550mm
 包装: 1980×960×140 mm



KS-323 (原KS-322a) 不锈钢床头双摇床 (型钢床面)
 Steel Two-crank Care Bed
 L2000×W900×H550mm
 包装: 1980×960×120 mm



KS-325 (原KS-322b) 全型钢双摇床
 Steel Two-crank Care Bed
 L2000×W900×H550mm
 包装: 1980×960×120 mm



KS-221 全不锈钢手摇二折床(手调式)
 S.S. One-function Care Bed (Adjustable backrest)
 L2000×W900×H550mm
 包装: 1980×960×130 mm



KS-212 全不锈钢单摇二折床(床头式)
 S.S. One-crank Care Bed
 L2000×W900×H550mm
 包装: 1980×960×130 mm



KS-213 (原KS-212a) 全不锈钢单摇二折床(床脚式)
 S.S. One-crank Care Bed
 L2000×W900×H550mm
 包装: 1980×960×130 mm



KS-215 (原KS-212b) 不锈钢床头单摇二折床 (型钢床面)
 Steel One-crank Care Bed
 L2000×W900×H550mm
 包装: 1980×960×110 mm



KS-216 (原KS-212c) 全钢型单摇病床
 Steel One-crank Care Bed
 L2000×W900×H550mm
 包装: 1980×960×110 mm



KS-110 全不锈钢平床
 KS-110: S.S. Flat Care Bed
 L2000×W900×H550mm
 包装: 1980×960×120 mm



KS-110a 不锈钢床头平床 (型钢床面)
 Steel Flat Care Bed
 L2000×W900×H550mm
 包装: 1980×940×110 mm



KS-110b 全钢型平床
 Steel Flat Care Bed
 L2000×W900×H550mm
 包装: 1980×940×110 mm



KS-522 双摇骨科牵引床 (全不锈钢)
 S.S. Two-crank Orthopaedics Bed
 L2000×W900×H550mm
 包装: 2120×940×320 mm

担架车系列

KS-B01 四小轮担架车
 S.S. Stretcher (Small Castors)
 L1900×W550×H700 mm
 包装: 1980×860×740 mm



KS-B01a 大轮担架车
 S.S. Stretcher (Big Wheel)
 L1900×W550×H700 mm
 包装: 1950×860×760 mm



KS-B02 三功能手摇急诊床车
 Manual Three-crank Emergency Stretcher
 L1950×W750×H550/820 mm
 包装: 1980×760×560 mm



KS-B03a 不锈钢急救车拖车
 Stainless Steel Emergency Stretcher
 L1900×W500×H400 mm
 包装: 1920×550×430 mm



KS-B04 手摇急诊床车
 S.S. Manual Emergency Stretcher
 L2010×W670×H560/800 mm
 包装: 2120×600×580 mm



KS-B04a 救护升降担架车
 Aluminum Emergency Stretcher
 L1900×W670×H260/880 mm
 包装: 2000×880×310 mm



KS-2112 不锈钢对接床车
 S.S. Joint Stretcher
 L3600×W570×H650/800 mm
 包装: 1860×640×600外车
 包装: 2150×710×730内车

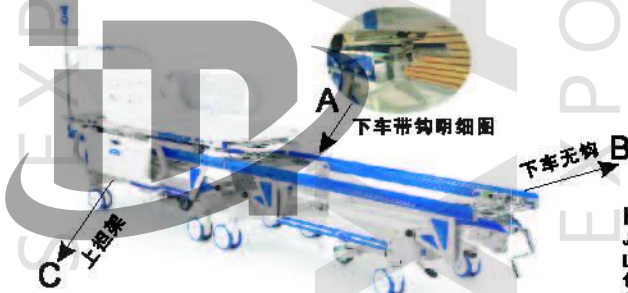

KS-2132 手术室对接担架车
 Jointing Stretcher For Operation Room
 L3650×W640×H640~970 mm
 包装: 1860×640×800外车
 包装: 2150×710×730内车

f(86) 186-8880-7020



KS-2032 ABS担架车(手播式)
 ABS Stretcher (hand travelling type)
 L1950×W840×H810~910 mm
 包装: 1960×700×620 mm



KS-2032(a) ABS豪华担架车(减压式)
 ABS Deluxe Stretcher (hand travelling type)
 L1930×W700×H830~930 mm
 包装: 1960×760×670 mm



KS-2032b 豪华液压升降平车
 Luxurious Hydraulic Rise-and-fall Stretcher Cart
 L2120×W800×H610~930 mm
 包装: 2160×880×760 mm

医用推车系列

KS-B10 不锈钢三层器械车
 S.S. Three-shelf Trolley
 L650×W420×H800+80 mm
 包装: 750×440×780 mm



KS-B07 二层器械车
 S.S. Two-shelf Trolley
 L700×W450×H800+80mm (大号) L
 L650×W420×H800+80mm (中号) M
 L500×W400×H800+80mm (小号) S
 包装: 600×470×780mm大
 包装: 750×440×780mm中
 包装: 600×420×790mm小



KS-B08 扇形器械车
 S.S. Scooped Trolley
 L1400×W450×H800+80 mm
 包装: 1430×640×790 mm



KS-B52 栅管式回收被服运输车
 S.S. Transport Trolley
 L1200×W800×H620 mm
 包装: 1430×850×950 mm



KS-B53 梯管式背易被服回收车
 S.S. Transport Trolley (Simple Design)
 L1000×W700×H800 mm
 包装: 1030×730×810 mm



KS-B54 大轮全封闭被服运输车
 S.S. Deluxe Transport Trolley
 L1140×W820×H830 mm
 包装: 1240×900×950 mm



KS-B11 不锈钢双抽治疗车 (静音轮子另购)
 S.S. Double-drawer Trolley
 L700×W480×H800+80 mm(大号) L
 L880×W480×H800+80 mm(小号) M
 包装: 790×470×810 mm大
 包装: 740×440×810 mm中



KS-B12 不锈钢治疗车 (静音轮子另购)
 S.S. Single-drawer Trolley
 L700×W480×H800+80 mm(大号) L
 L880×W420×H800+80 mm(小号) M
 L900×W400×H800+80 mm(小号) S
 包装: 800×480×800 mm大
 包装: 750×450×800 mm中
 包装: 800×430×800 mm小



KS-B15 不锈钢麻醉车(四脚)
 S.S. Anesthesia Trolley
 L500×W400×H800 mm
 包装: 800×420×720 mm



KS-B16 不锈钢清创车
 S.S. Cleaning Trolley
 L800×W400×H800 mm
 包装: 830×430×700 mm



KS-B18 不锈钢清创车
 S.S. Cleaning Trolley
 L600×W400×H800 mm
 包装: 520×420×820 mm



KS-B22 不锈钢漏斗送药车(60格)
 S.S. Medicine Trolley
 L600×W400×H800 mm
 包装: 700×420×710 mm



KS-B23 不锈钢送药车(双抽)
 S.S. Double-drawer Medicine Trolley
 L800×W450×H800 mm
 包装: 830×490×730 mm



KS-B24 不锈钢换药车
 S.S. Dressing Trolley
 L640×W420×H800+80 mm
 包装: 730×440×790 mm



KS-B41 不锈钢平板推车
 S.S. Flat Cart
 L800×W500×H200 mm
 包装: 820×520×320 mm



KS-B41a 不锈钢平板推车
 S.S. Flat Cart with Sideralls
 L800×W500×H200 mm
 包装: 830×530×480 mm



KS-B42 不锈钢手术升降台
 S.S. Surgical Table
 L450×W350×H800~1300 mm
 包装: 800×400×890两合/箱



KS-B42b 不锈钢升降手术盒架
 S.S. Surgical Table
 L700×W430×H820 mm
 包装: 720×460×760 mm



KS-B1017 ABS小推车
 ABS Trolley
 L710×W480×H910 mm
 L610×W370×H830 mm
 包装: 830×730×980/480×130 mm



KS-B1018(原KS-1017a) ABS小推车
 ABS Trolley
 L710×W480×H910 mm
 L610×W370×H930 mm
 包装: 630/730×390/480×160mm



KS-B1019(原KS-1017b) ABS小推车
 ABS Trolley
 L710×W480×H910 mm
 L610×W370×H930 mm
 包装: 630/730×390/480×230mm



KS-B1020(原KS-1017c) ABS小推车
 ABS Trolley
 L660×W480×H950 mm
 L610×W370×H930 mm
 包装: 630/680×390/480×260mm



KS-B1021(原KS-1017d) ABS小推车
 ABS Trolley
 L650×W480×H850 mm
 L610×W370×H930 mm
 包装: 630/680×390/480×230mm



KS-B25 不锈钢抢救车 I 型
 I Style S.S. Emergency Trolley
 L650×W420×H850 mm
 包装: 750×450×780 mm



KS-B28 不锈钢抢救车 II 型
 II Style S.S. Emergency Trolley
 L650×W420×H850 mm
 包装: 850×450×780 mm



KS-B26 不锈钢两层被服车
 S.S. Two-tier Transport Trolley
 L900×W500×H800 mm
 包装: 1010×820×980 mm

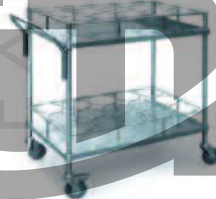

KS-B29 不锈钢开水瓶推车
 S.S. Hot Water Trolley
 L870×W544×H800 mm
 包装: 970×670×890 mm



KS-B33 不锈钢全封闭储藏运输物车
 S.S. Stock Trolley
 L900×W600×H800 mm
 包装: 1100×820×890 mm



KS-B34 不锈钢污物车
 S.S. Dirty Linen Trolley
 L550×W550×H800 mm
 包装: 570×570×780 mm



KS-B35 不锈钢护理车
 S.S. Clean Linen Trolley
 L830×W480×H800 mm
 包装: 960×510×810 mm



KS-B35a ABS 展间护理车
 Deluxe Linen Trolley
 L1180×W670×H1000 mm
 包装: 910×610×1190 mm



KS-B38 不锈钢氧气瓶推车
 S.S. Oxygen Trolley
 L430×W500×H1300 mm
 包装: 430×430×1260 mm



KS-B45 ABS麻醉车
 ABS Anesthesia Trolley
 L720×W480×H890 mm
 包装: 930×520×900 mm



KS-B46 ABS送药车 (ABS面板塑料车身)
 Medicine Serving Trolley
 L720×W480×H890 mm
 包装: 930×520×900 mm

多功能护理车系列

KS-320D 抢救车
 Emergency Cart
 L630 x W470 x H910mm
 包装: 720x560x70mm

KS-820CL-1 抢救车
 Emergency Cart
 L700 x W480 x H910mm
 包装: 710x520x920mm

KS-860AL 全ABS豪华送药车
 Medicine Cart
 L700 x W480 x H910mm
 包装: 710x520x820mm

(展开图)

KS-860CH-1 送药车
 Medicine Serving Trolley
 L700 x W480 x H910mm
 包装: 710x520x820mm

KS-380D 麻醉车
 Anaesthesia Trolley
 L630 x W470 x H910mm
 包装: 720x560x920mm

KS-310C ABS豪华治疗车
 Dressing Trolley
 L630 x W470 x H910mm
 包装: 720x560x870mm

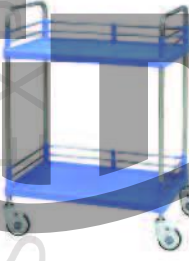
KS-550 型带电动推车 (一体机)
 COMPUTER CART
 L630 x 470 x 910

KS-202 塑钢治疗车
 Treatment Trolley
 L720 x W460 x H900mm
 包装: 740x480x240mm

KS-202C 塑钢治疗车
 Treatment Trolley
 L720 x W480 x H900mm
 包装: 740x480x270mm

KS-203 塑钢治疗车
 Treatment Trolley
 L720 x W460 x H900mm
 包装: 740x480x270mm

KS-310C-1 全ABS输液车 (换药车)
 Infusion Trolley
 L630 x W470 x H910mm
 包装: 720x560x870mm

KS-B58 全塑钢豪华麻醉车
 ABS Deluxe Anesthetic Trolley
 L845 x W475 x H1000-500 mm
 包装: 770x550x1000 mm

KS-B13 ABS治疗车(双抽)
 Treatment Trolley (Double Drawer)
 L720 x W480 x H900 mm
 包装: 790 x 560 x 900 mm

KS-B13a ABS治疗车(单抽)
 ABS Treatment Trolley (Single Drawer)
 L720 x W480 x H900mm
 包装: 790 x 560 x 900mm



KS-B52 全塑钢抢救车
 ABS Emergency Trolley
 L850×W460×H1010 mm
 包装: 810×480×870 mm



KS-C01 不锈钢病历柜车
 S.S. Patient Record Trolley
 L350/480×W350×H935 mm
 L980×W360×H1085/1145/1235 mm
 包装: 750×430×1000mm



KS-C01a 全ABS病历柜车
 ABS Patient Record Trolley
 L404×W404×H1060 mm (30格)
 L785×W408×H1039 mm (50格)
 包装: 430×430×930 mm
 包装: 610×460×910 mm



KS-D05 ABS 床上桌
 ABS Over Bed Table
 L800×W400×H750~1000 mm
 包装: 880×510×470两合/包



KS-D05a ABS 床上桌
 ABS Over Bed Table
 L800×W400×H750~1000 mm
 包装: 880×510×470两合/包



KS-D05f ABS 床上桌
 ABS Over Bed Table
 L800×W400×H750~1000 mm
 包装: 880×510×470两合/包



KS-D05b 美化板床上桌(塑钢)
 Over Bed Table
 L800×W400×H750~1000 mm
 包装: 830×450×300两合/包



KS-D05c 美化板床上桌(塑钢)
 Over Bed Table
 L800×W400×H750~1000 mm
 包装: 830×450×300两合/包



KS-D05d 美化板床上桌(塑钢)
 Over Bed Table
 L800×W400×H750~1000 mm
 包装: 830×450×300两合/包

医院用柜系列



KS-C02 不锈钢自动感应洗手槽
 Automatic Washing Sink
 L1800~1800×W860×H850×360 mm
 包装: 1630/1630×630×1210 mm



KS-C03 不锈钢胃肠镜消毒槽(I型)
 I Style Sterilized Sink For Gastrointestinal
 L1200/1820×W420×H850 mm (三槽)
 L1800/2030×W580×H800 mm (四槽)
 包装: 1630/1630×450×820mm
 包装: 1630/2030×580×830mm



KS-C04 不锈钢胃肠镜消毒槽(II型)
 II Style Sterilized Sink For Gastrointestinal
 L1850/1800×W420×H800 mm (三槽)
 L1850/2000×W550×H800 mm (四槽)
 包装: 1630/1630×450×830 mm
 包装: 1630/2030×580×830 mm



KS-C05 不锈钢豪华自动感应洗手槽
 Luxurious Automatic Washing Sink
 L1800×W860×H900×1000mm
 包装: 1630×710×1030 mm



KS-C06a 不锈钢洗涤台(三槽)
 S.S. Washing Unit (Three Sinks)
 L1800×W800×H800 mm
 包装: 1630×630×860 mm



KS-C06b 不锈钢洗涤台(双槽)
 S.S. Washing Unit (Double Sink)
 L1800×W600×H800 mm
 包装: 1620×620×870 mm



KS-C07a 胃镜柜
 Gastroscope Cabinet
 L900×W400×H1980 mm
 包装: 930×430×2010 mm



KS-C08b 不锈钢器械柜
 S.S. Medicine Cabinet
 L900×W400×H1750 mm
 包装: 930×430×1770 mm



KS-C08c 四门器械柜
 Four Doors cabinet
 L980×W400×H1765mm
 包装: 1010×430×1800mm



KS-C09 不锈钢治疗柜
 S.S. Medicine Cabinet
 L1200/1500×W200/500×H800/1080 mm
 包装: 1230/1530×530×2010 mm



KS-C10 水剂调剂柜
 S.S. Cabinet for Inhalation
 L1200/1500×W300/800×H800/1080 mm
 包装: 1230/1530×630×2010 mm



KS-C17 双面西药调剂柜
 Double-face Medicine Cabinet
 L1800×W700/1100×H900/1080 mm
 包装: 1920×720×1090
 包装: 1920×870×920两箱



KS-C17b 单面西药调剂柜
 Single-face Medicine Cabinet
 L1800×W800/900×H800/1080 mm
 包装: 1800×820×820mm—箱
 包装: 1920×920×1080mm—箱



KS-C17a 双面西药调剂柜
 Double-face Western Medicine Cabinet
 L1200/1500/1800×W300/800×H800/1080 mm
 包装: 1220/1620/1920×630×820—箱
 包装: 1220/1520/1920×330×1110—箱

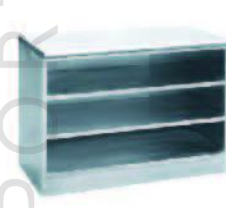

KS-C40 发药台
 Dispensing Table
 L1200/1500×W800×H800 mm
 包装: 1220/1520×820×820 mm



KS-C11b 不锈钢工作台
 S.S. Working Table
 L1200/1400×W750×H800 mm
 包装: 1220/1420×770×680 mm



KS-C13 地柜
 S.S. Cabinet
 L1200×W800×H800 mm (三门三抽)
 L1500×W600×H900 mm (四门四抽)
 包装: 1230/1530×530×830 mm



KS-C14 电脑发药台
 Computer Distributing Desk
 L1200/1400×W800×H800 mm
 包装: 1230/1430×820×830 mm



KS-C12 八门中药柜
 Chinese Medicine Cabinet with Eight Doms
 L980×W400×H1980 mm
 包装: 1010×430×2010 mm



KS-C15 颗粒药柜
 Cabinet for Granular Medicine
 L980×W400×H1980 mm
 包装: 1010×430×1010 mm两箱



KS-C23a 库房成药架
 Shelf for Medicine
 L1000/1500×W500×H1440 mm
 包装: 1030/1530/530×310 mm 一箱
 包装: 2030×150×80 mm 一箱



KS-C23e 栅栏式固定药(货)架
 Shelf for goods
 L900/1200/1500×W800×H1800 mm
 包装: 930/1230/1530×830×1830mm



KS-C19 立式中药柜
 Chinese Medicine Cabinet
 L980×W400×H1980 mm
 包装: 1000×430×2000mm



KS-C18 组合西药调剂柜
 Western Medical Cabinet Unit
 L4500×W1700×2×H1900+1060 mm
 包装: 630×830×2030 mm 两箱
 包装: 1130×830×2030 mm 五箱

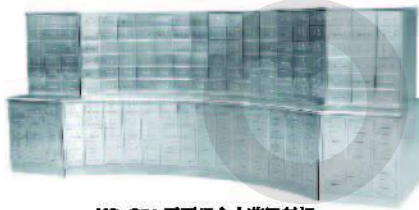

KS-C21 弧型组合中药调剂柜
 Arched Chinese Medicine Cupboard Unit
 L480 (758×2+2680) ×W850/1050×H960+1080 mm
 包装: 780×980×1110两箱
 包装: 780×1880×930两箱
 包装: 1480×1880×930两箱
 包装: 1480×980×1110两箱



KS-C22 可调双斗成药架
 Medicine Shelf
 L980×W500×H1980 mm
 包装: 1000×520×2000mm



KS-C22a 单向可调式药盘架
 Drug-way adjustable drug plate
 L1200×W480×H2000 mm
 包装: 1220×480×2020



KS-C22b 双向可调式药盘架
 Two-way adjustable drug plate
 L800×W860×H2000 mm
 包装: 830×430×830两箱
 包装: 2030×430×80一箱



KS-C23 成药架
 Medicine Shelf
 L980×W400×H1980 mm
 包装: 1010×430×2000 mm



KS-C20 双面中药调剂柜
 Double-face Chinese Medicine Cupboard
 L1980×W850/1200×H900+1080 mm
 包装: 2000×1220×930mm两箱
 包装: 2000×530×1110两箱



KS-C20a 单面中药调剂柜
 Single-face Chinese Medicine Cupboard
 L1980 x W300/600 x H1980mm
 包装: 2000×820×830mm 一箱
 包装: 2000×320×1110mm 一箱



KS-C36 中药柜 | 型
 Chinese Medicine Cabinet | Style
 L1200×W880/900×H800+1080 mm
 包装: 1220×830×930 mm



KS-C37 仿家属中药柜
 S.S. Traditional Chinese Medicine Cupboard
 L2000×W815×H2150 mm
 包装: 2020×840×1100mm(两箱)



KS-C31 不锈钢试验台
 Stainless Steel Laboratory Table
 L3000×W1200/250×H800+1080 mm
 包装: 1580×1220×920mm 两箱
 包装: 1580×640×1110mm 一箱



KS-C32百折门药架
 Medicine Cabinet
 L980×W400×H1980 mm
 包装: 1010×430×2010 mm



KS-C33 贵重药品柜
 Medicine Locker
 L980×W400×H1980 mm
 包装: 1010×430×2010 mm



KS-C34 双面中药调剂柜
 Double-face Chinese Medicine Cupboard
 L1500*W800/1300*H800+1080 mm
 包装: 1530*890*930 两箱
 包装: 1530*890*1110 一箱



KS-C23b 钢层库房重货货架
 Steel Shelf for Goods Heavy Duty
 L1200/1500/1800*W800/900/1200 mm
 包装: 2020*500*320mm



KS-C43 钢层可调式双面西药架
 Steel Double-face Western Medicine Shelf
 L1200*W1055/1155*H1360/1600/2000 mm
 包装: 2020*550*340mm



KS-C24a 网式单面西药架
 Steel Western Medicine Shelf
 L1200*W810/580*H1800/2000 mm
 L800*W812*H1800 mm (单面)
 L1200*W1055/1155*H1200/2000 mm
 L800*W855*H1800 mm (双面)
 包装: 1330*630*1801mm 包装: 2030*1220*90mm



KS-C24 单面六层成药架
 Medicine Shelf (Six Layers)
 L800*W400*H1880 mm
 包装: 830*430*240mm
 包装: 2030*930*90mm



KS-C39 无门药架
 Medicine Shelf without Door
 L880*W400*H1980 mm
 包装: 1010*430*2010 mm



KS-C25 ABS床头柜 (天蓝色)
 ABS Bedside Cabinet
 L480*W480*H780 mm
 包装: 500*500*780 mm



KS-C26 ABS床头柜 (灰色)
 ABS Bedside Cabinet
 L450*W480*H760 mm
 包装: 400*470*770 mm



KS-C26a ABS床头柜
 ABS Bedside Cabinet
 L480*W480*H870 mm (不含轮)
 L480*W480*H930 mm (含轮)
 包装: 490*490*880 mm



KS-C27 ABS面塑钢床头柜
 ABS Bedside Cabinet
 L480*W410*H800 mm
 包装: 520*430*810 mm



KS-C26b ABS面塑钢床头柜
 Steel Bedside Cabinet
 L480*W410*H800 mm
 包装: 490*420*810 mm



KS-C26d ABS面塑钢床头柜
 ABS Bedside Cabinet
 L480*W480*H870 mm
 包装: 480*480*880 mm



KS-C28 不锈钢床头柜 (无后斗)
 Stainless Steel Bedside Cabinet
 L400*W420*H780 mm
 包装: 420*430*780 mm



KS-C29 不锈钢床头柜 (有后斗)
 Stainless Steel Bedside Cabinet
 L400*W420*H760 mm (有后斗)
 包装: 470*820*770 mm



KS-C30 木质床头柜
 Wooden Bed Side Cabinet
 L480*W480*H760 mm
 包装: 500*500*770 mm

输液椅床垫系列

KS-Q01 不锈钢落地式输液架
 Stainless Steel I.V. Stand
 包装: 杆 1100×280×150 十五个/包
 包装: 脚 500×500×800 十五个/包



KS-Q01a 不锈钢落地式输液架
 Stainless Steel I.V. Stand
 包装: 杆 1100×280×150 十五个/包
 包装: 脚 600×600×800 十五个/包



KS-Q02 不锈钢落地式输液架
 Stainless Steel I.V. Stand
 包装: 杆 1100×280×150 十五个/包
 包装: 脚 500×500×800 十五个/包



KS-Q02a 不锈钢落地式输液架
 Stainless Steel I.V. Stand
 包装: 杆 1100×280×150 十五个/包
 包装: 脚 500×500×800 十五个/包



KS-Q34 反光灯
 Reflector Lamp
 1000-1500 mm
 包装: 1030×300×120 两个/包



KS-Q08 婴儿身高测量器
 Baby Measuring
 L1050×W420×H120 mm
 包装: 1070×440×240 两个/包



KS-Q09 双梯槽脚踏开启架
 Foot Control Cupboard (Double)
 L700×W400×H800/1200 mm
 包装: 730×430×1230 mm



KS-Q09a 单梯槽脚踏开启架
 Foot Control Cupboard (Single)
 L400×W400×H800/1200 mm
 包装: /490×420×810/1210 mm



KS-D10 双层塑钢脚踏凳
 Steel Patient Step (Two)
 L390×W580×H140/280 mm
 包装: 410×610×450 两个/包



KS-D10a 单层塑钢脚踏凳
 Steel Patient Step (One)
 L380×W280×H140 mm
 包装: 420×360×190 两个/包



KS-D12 不锈钢手术凳(四脚)
 S.S. Stool with Four Legs
 φ320×480/550 mm
 包装: 350×350×550 两个/包



KS-D13 手术转椅
 Injection Chair
 φ320×430/560 mm
 包装: 330×330×480 两个/包



KS-D14a 不锈钢五官科椅
 S.S. Ophthalmology and Otorhinolaryngology Chair
 L680×W520×H1200 mm
 包装: 660×870×980 mm



KS-D15 医生转椅(镀铬)
 Doctor's Whirl Stool
 φ320×430/560 mm
 包装: 480×480×480 两个/包



KS-D16 靠背转椅(镀铬)
 Whirl Stool with Backrest
 φ340×480/580 mm
 包装: 480×480×460 两个/包



KS-Q17 塑钢紫外线杀菌车
 Ultraviolet Ray Sterilized Cart
 L420×W440×H1150×750 mm
 包装: 450×470×1200mm



KS-Q18 不锈钢手套凉架
 Glove Shelf
 A. 64支 B. 32支
 包装: 600×450×1500mm



KS-Q22 不锈钢屏架
 Stainless Steel Screen
 2/3/4折
 包装: 1700×540×100(四折)



KS-P23 三折床垫
 Mattress for Three Sections
 L1950×W840×H50/80 mm
 包装: 1980×850×320四件/包



KS-P24 二折床垫
 Mattress for Two Sections
 L1950×W840×H50/80 mm
 包装: 1980×850×320四件/包



KS-P25 平床垫
 Mattress Flat
 L1950×W840×H60/80 mm
 包装: 1980×850×320四件/包



KS-P28 骨科床专用床垫
 Mattress for Orthopedic Bed
 L1850×W840×H50/80 mm
 包装: 1880×850×320四件/包

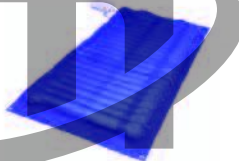

KS-P27 防褥疮气垫 I 型
 Air Mattress
 L1950×W850×H60mm
 包装: 705×360×360三件/包



KS-P27a 防褥疮气垫 II 型
 L1950×W850×H60mm
 包装: 705×360×360三件/包



KS-P27b 防褥疮气垫 III 型
 L1950×W850×H60mm
 包装: 705×360×360三件/包



KS-P27c 防褥疮气垫 IV 型
 L1950×W850×H60mm
 包装: 705×360×360三件/包



KS-Q29 送药箱
 Stainless Steel Medicine Box
 L500×W300×H100/400 mm
 包装: 630×320×420 mm



KS-Q30 不锈钢病历夹
 S.S Patient Recorder
 L230×W315 mm
 包装: 360×230×260二十件/包



KS-Q30a ABS病历夹
 ABS Patient Recorder
 L230×W315 mm
 包装: 350×230×250二十件/包



KS-P31 天轨输液吊杆(30厘米)
 Hanging Infusion Stand
 0.8/1.0/1.1/1.2/1.3/1.4/1.5 m
 包装: 1550×230×260十支/包



KS-P31a 天轨输液吊杆(1900厘米)
 Hanging Infusion Stand
 1900×900 mm(上横)
 包装: 1930×830×40mm

输 液 椅 系 列

KS-D32 输液椅(三人位)
 Infusion Chair (Three Seats)
 1240/1860/2480 mm
 包装: 2160*600*700两个/箱
 包箱: 810*610*890两个/箱



KS-D35 输液椅(钢制)
 Waiting Chair
 L2280*W790*H960/830 mm (三人位)
 L1540*W780*H860/830 mm (两人位)
 L840*W790*H860/830 mm (单人位)
 包装: 1150*550*80床架
 包箱: 700*800*120床架

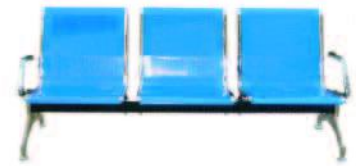

KS-D36 钢制候诊椅
 Waiting Chair Three Seats
 L1800*W680*H450/600 mm
 包装: 1860*750*750两件/包



KS-D36a 不锈钢候诊椅
 Waiting Chair Three Seats
 L1800*W680*H450/600 mm
 包装: 1850*750*750两件/包



KS-D36b 不锈钢候诊椅
 Waiting Chair Three Seats
 L1800*W850*H1000mm
 包装: 800*600*600mm



KS-D45 不锈钢输液椅
 stainless steel infusion chair
 L1998*W650*H1000mm



KS-D38 不锈钢输液椅
 Steel Infusion Chair
 L650/1140*W650*H450-1060mm
 包装: 680*680*1150mm



KS-D38b 不锈钢输液椅(带扶手)
 Stainless Steel Infusion Chair
 L820*W720*H450/1060mm
 包装: 1120*730*1280两个/包



KS-D38b 不锈钢输液椅(另选购实木扶手)
 Stainless Steel I.V. Rod
 L850/1140*W720*H450/1060mm
 包装: 1000*680*1100mm



KS-D41 钢制输液椅 I 型
 Steel Infusion Chair
 L650*W650*H450/1060mm
 包装: 1040*770*1680两个/包



KS-D40b 钢制陪人椅(深蓝色)
 Sleeping Chair Steel Powder Coated (Dark Blue)
 坐宽: L810*W820*H460/830mm
 卧宽: L1800*W650*H450
 包装: 870*660*680拆装式



KS-D40 陪人椅(床)(棕色)
 sleeping Chair
 坐宽: L820*W850*H450/1060
 卧宽: L1900*W850*H450
 包装: 860*660*1350两个/包



KS-D37 陪人椅(床)(型钢)
 Sleeping Chair
 坐宽: L820*W850*H450/1060
 卧宽: L1900*W850*H450
 包装: 860*660*1350两个/包



KS-D40 陪人椅(床)(型钢)
 Sleeping Chair
 坐宽: L820*W850*H450/1060
 卧宽: L1900*W850*H450
 包装: 800*660*1350两个/包



KS-D88 豪华固定型输液椅
 Deluxe Fixed Infusion Chair
 L920*W795*H600mm
 包装: 780*710*1020mm



KS-D90 豪华固定型输液椅
 Deluxe Fixed Infusion Chair
 L920*W795*H800mm
 包装: 780*710*1020mm



KS-Q70 隔帘(直型、L型、U型)
 Medical Curtain (天蓝、粉红、黑绿、米黄)
 L2900*~2800*W2400*~8000mm
 包装: 800*800*250十件/包



医用配件系列

KS-P74 双面豪华脚轮
 Double-face Deluxe Castor
 φ 125 mm
 包装: 480×270×280十六件/箱



KS-P75 中控脚轮
 Deluxe Castor
 φ 125 mm
 包装: 480×270×280十六件/箱



KS-P76 普通脚轮
 Normal Castor
 φ 125 mm
 包装: 480×270×280十六件/箱



KS-P77 插杆式豪华脚轮
 Deluxe Castor
 φ 125 mm
 包装: 480×270×280十六件/箱



KS-P72 全ABS弧形伸缩式餐板
 ABS Aro-shaped Flexible Ove Bed Table
 L900×W400×H25 mm
 包装: 835×315×415六个/包

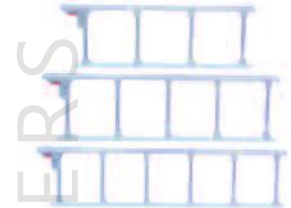

KS-P78a 四档 (Four Sections)
 L980×W420 mm
KS-P78b 五档 (Five Sections)
 L1220×W420 mm
KS-P78c 六档 (Six Sections)
 L1480×W420 mm

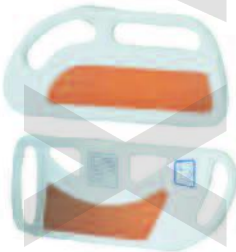

KS-P79-1 PP 长握护栏(无接开关)
 PP Siderall (Length)
 L700×W300 mm
 包装: 1200×200×330两件/包

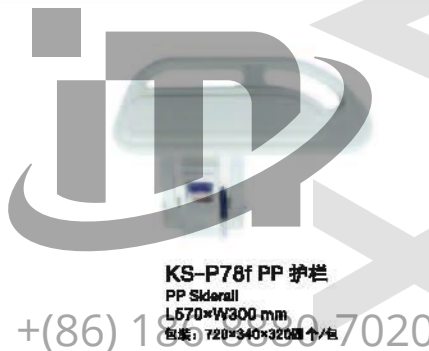

KS-P78f PP 护栏
 PP Siderall
 L670×W300 mm
 包装: 720×340×320四个/包



KS-P79 PP 加长护栏
 PP Siderall (Length)
 L700×W300 mm
 包装: 1200×200×330两件/包



KS-P80 不锈钢插式护栏
 Stainless Steel Backsaddle
 L800×W450 mm
 包装: 810×480×80两个/包



KS-P81 电动PP护栏床头尾板
 electrical PP sideralls, electrical head foot boards
 床头尾板 L910×W680 mm
 PP护栏 L720×W350 mm
 包装: 820×170×800两件/包
 包装: 700×380×350四件/包



KS-P85 光面ABS床头尾板
 ABS Head and Foot Board
 L930×W680×H80 mm
 包装: 960×850×125 mm
 包装: 980×580×150 mm

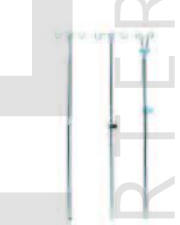

KS-P82 伸缩输液架
 Flexible I.V. Stand
 φ L18-19×W660-1600 mm
 包装: 1000×180×180十个/包

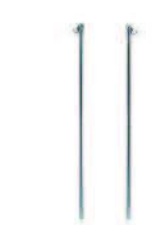

KS-P83 广型蚊帐架
 Steel Mosquito Netting Shelf
 φ L15×W120 mm
 包装: 1230×120×120十六个/包

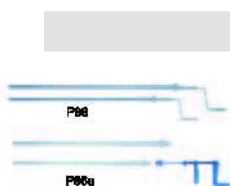

KS-P86 不锈钢床脚踏板
 Crank with Stainless Steel Handle
 φ L32×W1020 mm
 包装: 200×200×1100十件/包

KS-P86a ABS 床脚踏板
 Crank with ABS Handle
 φ L32×W1020 mm
 包装: 200×200×800十件/包



KS-Q27a 灰色防撞扶手
 Double seat-proof head-guard
KS-Q27b 灰色防撞扶手
 Head-guard
 Head-guard



KS-Q21 四爪拐杖
 Aluminum Quad Cane
 L780×W29×H430 mm
 包装: 800×200×540



KS-Q21a 铝制肘拐杖
 Crutches
 L1370×W330×H270 mm
 包装: 1400×350×80 一付/包



KS-D18a 可调式钢轮椅
Steel Wheelchair Adjustable
L800xW1280xH1100/1270 mm(实物)
L880xW1350xH1180 mm(包装)



KS-D806 轮椅
Steel Wheelchair
L830 x W860 x H890mm
包装: 830x230x890mm



KS-D600 轮椅
Steel Composite Wheelchair
L1160 x W830 x H1200mm
包装: 850x340x1200mm



KS-D801 带便桶轮椅
Steel Commode Wheelchair
L800 x W860 x H890mm
包装: 780x230x890mm



KS-D882L 助步器
Hand Deluxe Aluminum Rollator
L840 x W810 x H710-820mm
包装: 430x230x800mm



KS-D55 洗澡凳
Bath Chair
L820xW460xH440/520 mm(实物)
L840xW520xH500 mm(二件包装)



KB-D55a 靠背洗澡凳
Bath Chair with Backrest
L1490xW480xH800/870x870 mm(实物)
L850xW610xH880 mm(附件包装)



KB-D55b 可移动坐便器
Commode Wheelchair
L850xW480xH800/840 mm(实物)
L880xW520xH880 mm(包装)



KB-D55c 坐便椅
Commode Chair
L460xW480xH530/570 mm(实物)
L830xW520xH890 mm(实物)
L880xW550xH930 mm(包装)

+ (86) 186-8880-7020



KS-D818 坐便器
Steel Folding Commode
L810 x W860 x H740/840mm
包装: 650x210x770mm



KB-Q20 带轮助行器
Aluminum Walker with Castors
L830xW680xH780/840 mm(实物)
L880xW1180xH780 mm(二件包装)



KS-Q20b 助行器
Walker
L820xW680xH820-880 mm(实物)
L880xW980xH830 mm(二件包装)



KS-D836 拐杖
Crutch
H845mm
包装: 680x390x410mm (实物)



KS-D832-1~8 拐杖
Care Sticks
H700-830mm
包装: 680x170x290mm (实物)



KS-D400 工程塑料脚踏凳
Patient Step
L400 x W300 x H80mm
包装: 420x340x180mm



KS-D500 铝合金脚踏凳
Patient Step
L400 x W600 x H80mm
包装: 420x340x180mm

医用器皿系列

KS-Q42 不锈钢消毒盒
 S.S. Sterilizing Box
 9寸有孔无孔
 12寸有孔无孔
 包装: 8寸280×180=180件/包
 包装: 12寸280×280=230件/包

KS-Q43 不锈钢腰子盘
 S.S. Kidney Plate (Medium Depth and Depth)
 L230×W192×H90 mm(大号)
 L210×W109×H44 mm(小号)
 L172×W77×H36 mm(小号)
 包装: 280×180×180十件/包
 包装: 840×130×180十件/包
 包装: 200×180×150十件/包

KS-Q44 不锈钢治疗盒
 S.S. Therapy Box
 L330×W166×H50 mm
 包装: 380×280×230四件/包

KS-Q46 不锈钢消毒盘
 S.S. Sterilizing Plate
 L340×W138×H25 mm(大号)
 L180×W118×H23 mm(中号)
 L178×W104×H25 mm(小号)
 包装: (大) 270×180×280十件/包

KS-Q48 不锈钢倒锥形镊子筒
 Nippers Can (Back Taper)
 L80×W195 mm(大号)
 L64×W160 mm(中号)
 L45×W105 mm(小号)
 包装: (大) 680×290×200十件/包

KS-Q49 贮槽(引伸型)
 S.S. Cupboard
 φ L170×W128 mm
 φ L200×W146 mm
 φ L230×W158 mm
 φ L280×W175 mm
 包装: (大) 280×280×200mm

KS-Q50 不锈钢医用方盘
 S.S. Square Plate
 φ L230×W140×H30 mm(有盖)
 φ L230×W170×H30 mm
 φ L310×W240×H30 mm
 φ L440×W300×H30 mm
 包装: (大) 470×330×100十件/包

KS-Q51 不锈钢换药碗
 S.S. Medical plates
 L180×W80 mm(大号)
 L142×W60 mm(中号)
 L125×W40 mm(小号)
 包装: (大) 180×180×140十件/包

KS-Q54 不锈钢药膏缸
 S.S. Mixer
 φ L100×W95 mm
 φ L100×W90 mm
 φ L100×W80 mm
 包装: (大) 230×550×110十件/包

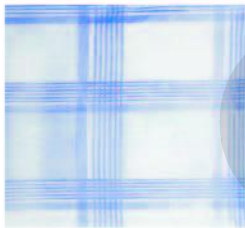
KS-Q55 不锈钢垃圾桶

E1204 全棉条纹床单

E1205 全棉条纹床单

E1210e 全棉卡通床单

E1209 白色医用床单
 White Medical Sheet

医用服装系列

E1006 夏装护士服

E1007 夏装护士服

E1008 夏装护士服

E1009 夏装护士服

E1010 夏装护士服

E1012 冬装护士服

E1005 冬装护士服

+(86) 186-8880-7020

E1013 冬装护士服

E0801/E0806 夏装医生服

E0805/E0802 冬装医生服

E1104/E1105 洗手服

E1018/E1019a 手术服

E1020 遗体手术服

E1201/E1202 病人服

E1202a 孕妇服

E1203/E1203a 病人服

E1203b/E1203c 工勤服

✿ 入院登记 Admission
Registration

✿ 出院结算 Discharge
Settlement

☎ + (86) 186-8880-7020

A →

出入院办理
Admission & Discharge

等候区
Waiting area



WELCOME

海达康医用家具展示中心
HEADWAY HEALTHCARE SHOW ROOM

海达康医用家具展示中心位于上海南京路，建筑面积 1500 平米，秉承海达康以患者、医护人员使用体验为核心的设计理念，历经数月打磨，在南京市举办的各利好峰会大获好评。

海达康医用家具展示中心规划六大展示区域：接待接待区、门诊区、住院区、医生办公区、医用产品展示区、医疗设备展示区，以海达康在医用家具方面强大的产品研发、制造能力，体现出海达康对医疗空间全方位解决方案的理解。

海达康医用家具从医院空间使用者的角度考虑，从外形造型、材质色彩、结构功能、无不遵循医疗空间各种医疗行为需求，将医用家具的普遍性和适用性相结合，有效提升医护人员的工作效率，防止患者情绪烦躁与抵触，营造出更加人性化的医疗就诊环境，以达到提高医疗品质的最佳作用。

海达康医用家具未来将进一步融合人工智能、AI 技术，成为智慧医疗的服务平台，现有力地推动中国智慧医疗的建设与发展。

(86) 186-8880-7020

← C

B

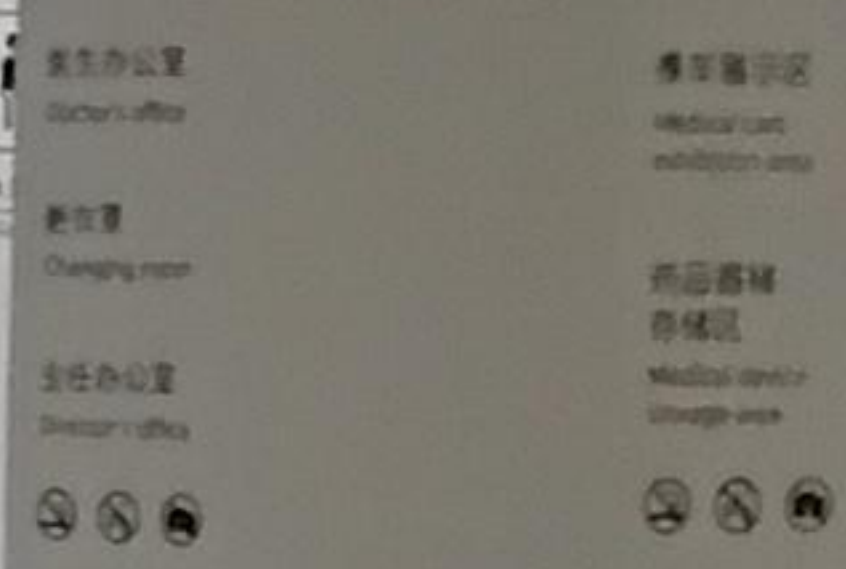



WELCOME

海达康医用家具展示中心 HEADWAY HEALTHCARE SHOW ROOM

海达康医用家具展示中心位于上海太庙路工业园，建筑面积1500平米，集展示、销售、研发、生产于一体，是海达康集团在华东地区的重要展示窗口。

海达康医用家具展示中心拥有六大展示区域：接待专区、门诊区、住院区、医生办公室、医生产品展示区、公共区域。海达康在医用家具方面拥有强大的产品研发、制造能力，能迅速对医疗行业全方位解决方案的提供。

海达康医用家具从医院使用场景的角度考虑，从外观设计、材料选择、结构制造、生产制造等环节进行全方位把控，将医用家具的耐用性和舒适性相结合，有效提升医护人员的工作效率，为患者提供更加舒适、安全、人性化的医疗环境，以达到提升医疗品质的最佳作用。

海达康医用家具秉承“以人为本”的设计理念，结合AI技术，成为智慧医疗的助推器，有力推动中国智慧医疗的建设与发展。

ALISA
REPLACEMENT
CONCEPT

← C B →
接待专区
Reception Area
医生办公室
Medical Office
医生展示区
Medical Show
公共区域
Public Area



+ (86) 186-8880-7020

HSP-4 3

WELCOME

海达康医用家具展示中心 HEADWAY HEALTHCARE SHOW ROOM

海达康医用家具展示中心位于海太南京工业园，建筑面积 1500 平米，秉承海达康以患者、医护人员使用体验为核心的设计理念，历经数月打磨，在南京美丽的金秋时节盛大开放。

海达康医用家具展示中心规划六大展示区域：接待候诊区、门诊区、住院区、医生办公区、医用产品展示区、医技产品展示区，凸显海太在医用家具方面强大的产品研发、制造能力，体现出海达康对医疗空间全方位解决方案的理解。

海达康医用家具从医院空间使用者的角度考虑，从外观造型、材质色彩、结构功能，无不遵循医疗空间各种医疗行为需求，将医用家具的普遍性和适用性相结合，有效提升医护人员的工作效率，也让患者倍感舒适与轻松，营造出更加人性化的医疗就诊环境，以达到提高医疗品质的最终作用。

海达康医用家具未来将进一步融合人类功效学、AI 技术，成为智慧医疗的服务载体，强有力地推动中国智慧医疗的建设与发展。

IMEXAO IMPORTERS EXPORTERS
+ (86) 186 8880-7020

WELCOME

海达康医用家具展示中心 HEADWAY HEALTHCARE SHOW ROOM

海达康医用家具展示中心位于海太南京工业园，建筑面积 1500 平米，秉承海达康以患者、医护人员使用体验为核心的设计理念，历经数月打磨，在南京美丽的金秋时节盛大开放。

海达康医用家具展示中心规划六大展示区域：接待候诊区、门诊区、住院区、医生办公区、医用产品展示区、医技产品展示区，凸显海太在医用家具方面强大的产品研发、制造能力，体现出海达康对医疗空间全方位解决方案的理解。

海达康医用家具从医院空间使用者的角度考虑，从外观造型、材质色彩、结构功能，无不遵循医疗空间各种医疗行为需求，将医用家具的普遍性和适用性相结合，有效提升医护人员的工作效率，也让患者倍感舒适与轻松，营造出更加人性化的医疗就诊环境，以达到提高医疗品质的最终作用。

海达康医用家具未来将进一步融合人类工学、AI 技术，成为智慧医疗的服务载体，强有力地推动中国智慧医疗的建设与发展。

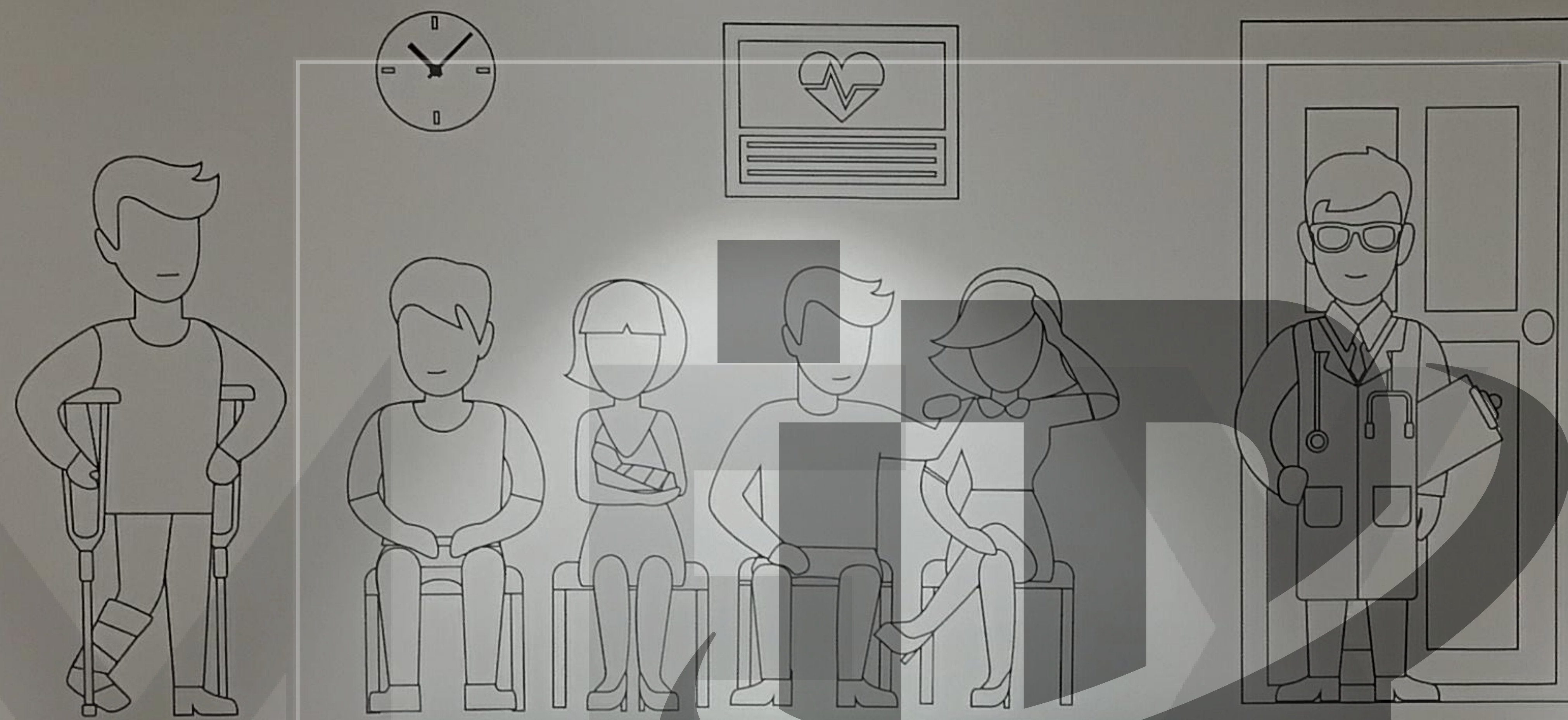

+ (86) 186-8880-7020

HSP-4 5



HSP-4 6



HSP-4 7



HSP-4 8



HSP-4 9

IMEXAO
IMPORTERS EXPORTERS
+ (86) 186-8880-7020



分诊台
Reception

+ (86) 186-8880-7020



+ (86) 186-8880-7020

HSP-4 12

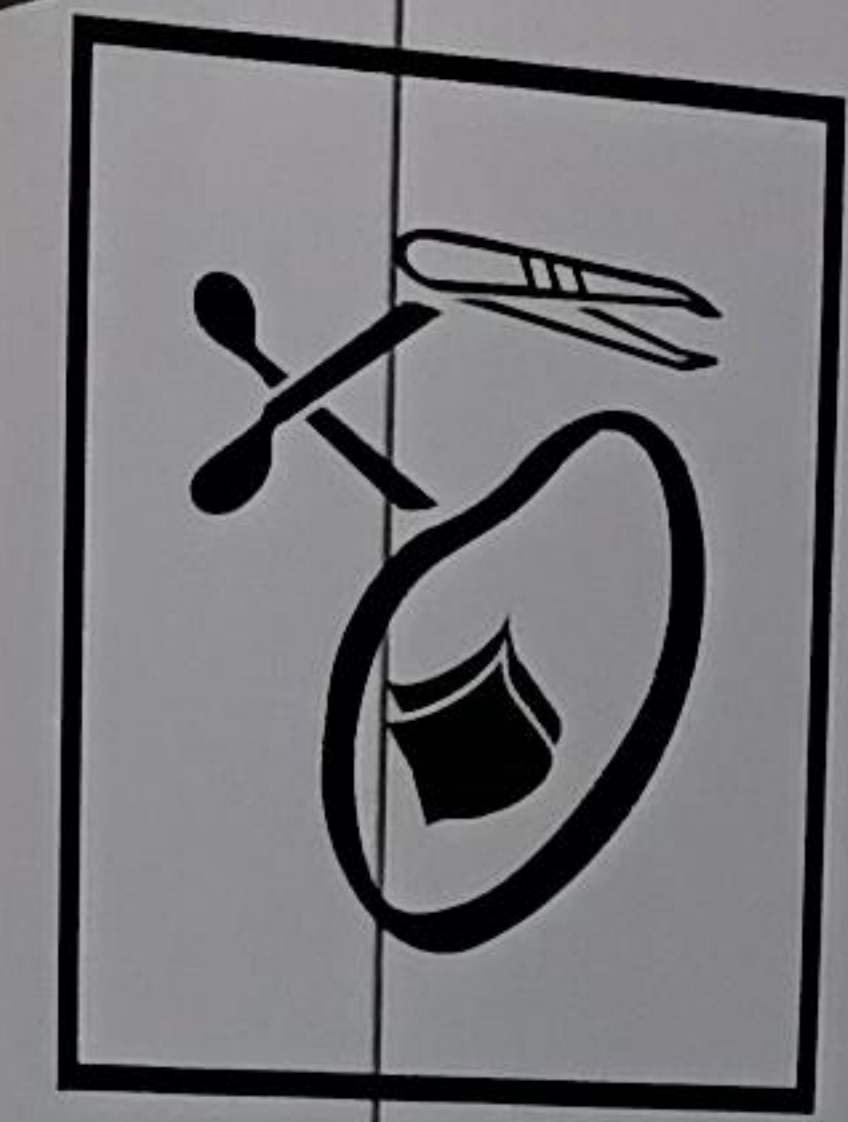

处置室
Disposal Room



IMPORTERS EXPERTS
+ (86) 186-8880-7020

HSP-4 13



+86 186 8880 7020

HSP-4 14



HSP-4 15

Thank You

We appreciate your time and attention. If you have any questions or need further information, please feel free to reach out.

 **CHINA OFFICE**

Room 19, 2nd Floor DeYi Commercial Building Construction
Road No. 4th, Lecong Town Shunde Foshan, Guangdong,
Postal code: 528 315

佛山市顺德区乐从镇建设路四号德怡商业大厦北门二楼19-3
铺 528315

 +(86) 186-8880-7020

 goldy@imexao.com



@imexao