



利华高贸易有限公司

# Hospital Catalogue 2024

SAMPLE 02

BUILD YOUR DREAMS WITH RELIABLE SOURCING FROM CHINA

 [www.imexao.com](http://www.imexao.com)

for  
19+ YEARS







导医台 NS01-YYXX75-MB-01  
规格:Φ6000×H1150



导医台 NS01-YYXX75-MB-02  
规格:Φ6000×H1150



导医台 NS01-YYXX75-MB-03  
规格:Φ6000×H1150

+ (86) 186-8880-7020

医院大厅中的导医台是患者和家属接触到的第一件医院家具。导医台代表医院整体形象，提供咨询、导医，周边突发情况协调处理。导医台设计新颖独特，功能齐全，满足导医咨询，是医院家具解决方案中的重点，它也是挂号收费、药房、门诊、住院、行政等功能区域的中枢纽带。

The guide reception in the hospital hall is the first furniture that the patients and their family members will encounter, which represents the overall image of the hospital, provides advice and guidance, and coordinates the response to surrounding emergencies. The design of the guide reception is novel and unique, with complete functions, which can meet the needs of guidance and consultation, and is the key point in the solution to hospital furniture. It is also a central link in the functional areas of registration charge zone, pharmacy, outpatient, hospitalization zone and administrative zone.



护士站

Nursing station



治疗室  
Therapeutic room

治疗室  
Therapeutic room

护士站  
Nursing station  
+ (86) 186 8880 7020





L型护士站 NS01-LXXX75-MB-01  
规格: W5560xH750/W2060xH750/H1100

护士站, 采用抑菌人造石台面, 抗菌面板柜身, 上台面配IPAD设备, 电话、票单格层。下台内部配置文件柜, 电脑柜, 键盘抽屉, 网络和电源插座, 报警器等。符合人体工程学的护士站不仅利于护士工作效率, 更能融合医患关系提升医院整体形象。

Nurse station adopts anti-bacterial artificial stone table, bacteria-free panel cabinet body, and upper table equipped with IPAD equipment, telephone, bills & documents layer. The internal configuration of the lower table is equipped with the file cabinet, computer cabinet, keyboard drawer, network and power socket, alarm, etc. The ergonomic nurse station not only helps nurses work in an efficient manner but also makes the relation between doctors and patients more harmonious, so as to improve the overall image of the hospital.

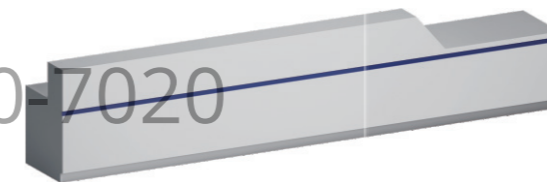

直型护士站 NS01-ZXXX75-MB-04  
规格: W5200xD750xH1150



直型护士站 NS01-ZXXX75-MB-02  
规格: W6350xD750xH1150



直型护士站 NS01-ZXXX75-MB-03  
规格: W5150xD1000/D750xH1030



L型护士站 NS01-LXXX75-MB-06  
规格: W5560xD750/W2060xD750/H1150

+ (86) 186-8880-7020





### L型护士站

"L-type Nurse Station"

医院护士站款式，L形状较多用于空间的夹角位置，例如等候大厅的角落、门诊大厅的靠墙位分诊台、住院病区拐角位的护士站。  
Hospital nurse station style, L shape is more used for the corner position of space, such as the corner of the waiting hall, the wall triage table in the outpatient hall, and the nurse station at the corner of the inpatient ward.



L型护士站 NS01-LXXX75-MB-02  
规格: W5000xH750/W2200xH750/H1150



L型护士站 NS01-LXXX75-MB-05  
规格: W7000xD750/W2030xD750/H1150



L型护士站 NS01-LXXX75-MB-03  
规格: W7525xH750/W3800xH750/H1150

护士站空间，站工作台设有电话 IPAD、护一转椅、住院患者一览表、留言板、文件柜、便携式应急灯、呼叫系统、手卫生设施，有墙面挂钟。"哈曼达"对多家医院的研究观察，从护士护理环境入手，开发了多款具有舒适安全、功能完善、款式新颖的护理护工工作站满足智慧医院整体建设需求。

Nursing station space, station work table is equipped with telephone IPAD, nursing swivel chair, inpatient list, message board, file cabinet, portable emergency light, call system, hand hygiene facilities, and wall clock. "HAMD" has researched and observed a number of hospitals, starting from the nursing environment of nurses, and has developed a variety of nursing workstations with comfortable, safe, perfect functions and novel styles to meet the overall construction needs of smart hospitals.



L型护士站 NS01-LXX75-MB-04  
规格: W4800xD750/W2250xD750/H1150

+ (86) 186-8880-7020



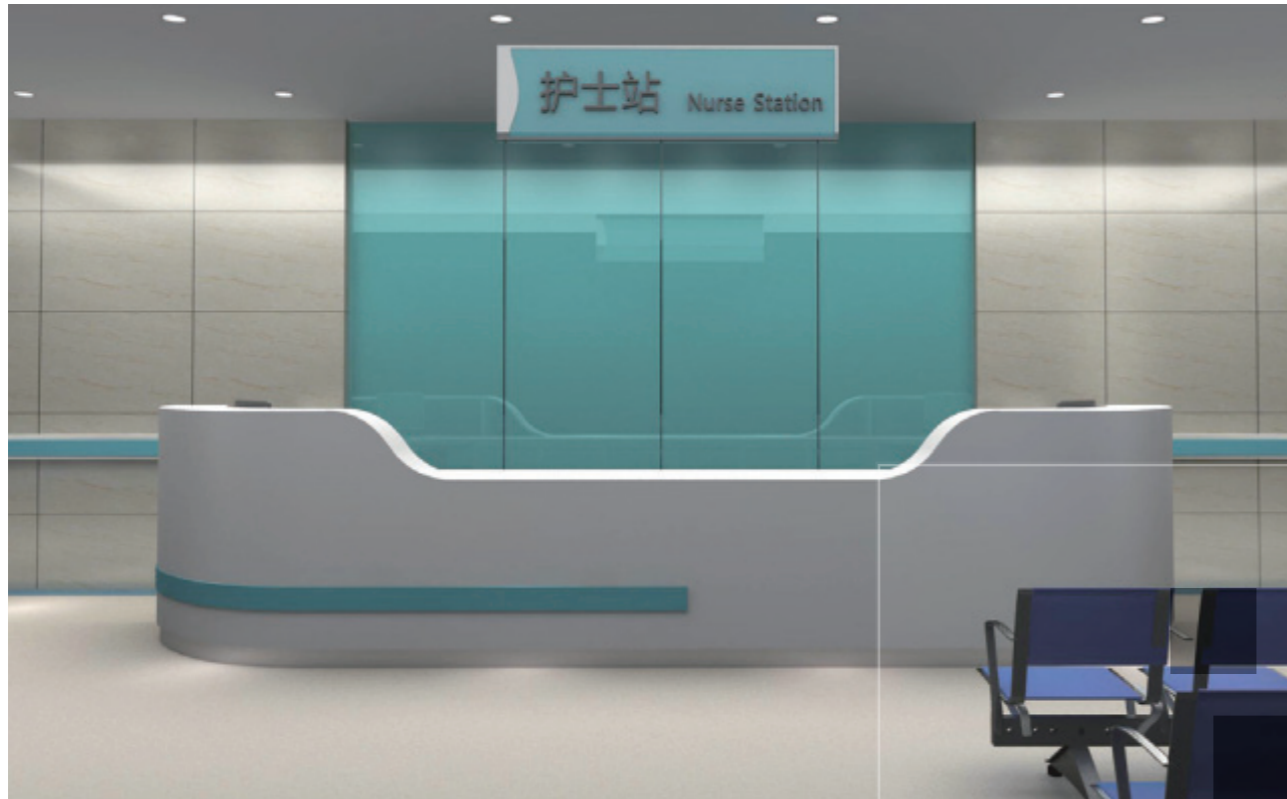

U型护士站 NS01-UXXX75-MB  
规格:W5200xD750/W2000xD750/H1150

**U型护士站**  
U-type Nurse Station

U形护士站, 适用于医院大厅宽敞空间, 两端围合形成U的工作站台, 占用面积大, 配有更多护士的工作位置和空间, 能提升医院整体形象。  
U-shaped nurse station, suitable for the spacious space of the hospital hall, the two ends are enclosed to form a U workstation platform, occupying a large area, equipped with more nurses' working position and space, can enhance the overall image of the hospital.



U型护士站 NS01-UXXX75-MB-02  
规格:W6400xD750/W2900xD750/H1100

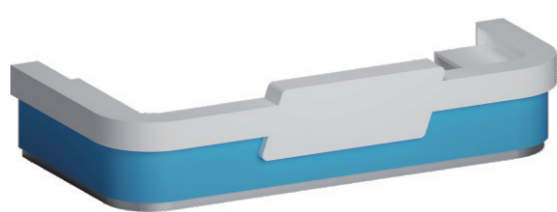

U型护士站 NS01-UXXX75-MB-03  
规格:W5000xD750/W2400xD750/H1100

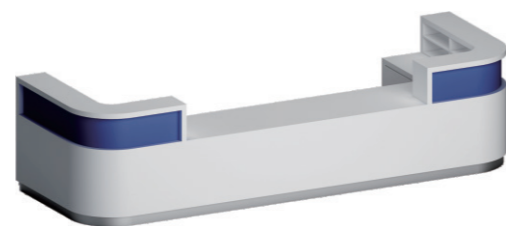

U型护士站 NS01-UXXX75-MB-04  
规格:W4500xD750/W1500xD750/H1100



诊床 CR08-ZC1965B-ES  
规格:W1900xD650xH680

**钢质型Steel type**

床采用优质钢质, 表面喷涂, PU自洁皮床垫, 加上可一次性换床单功能, 外观时尚、简洁; 结构稳固, 经久耐用。

The bedstead is made of high quality steel, surface spraying PU self-cleaning mattress, plus a disposable bed sheet function. The appearance is fashionable and succinct; the structure is stable and durable.

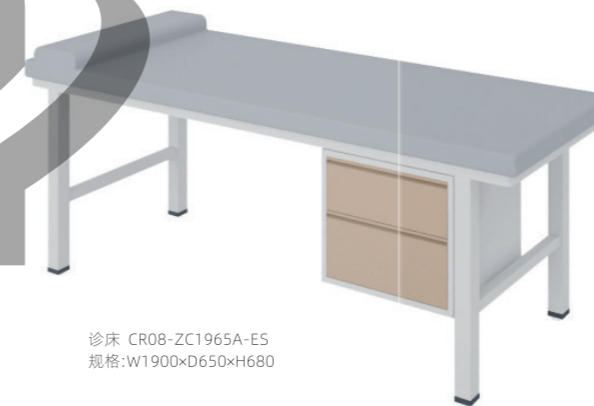

诊床 CR08-ZC1965A-ES  
规格:W1900xD650xH680

**钢架型Frame type**

床架采用优质钢管, 表面喷涂, 外观时尚、简洁; 结构稳固, 经久耐用。

The bed frame uses the high quality steel tube, surface spraying, stylish appearance, simple and stable structure, durable.

+ (86) 186-8880-7020



诊床 CR02-ZC1965G-MB  
规格:W1900xD650xH680

整个床架采用钢制, 品牌冷轧钢管制造, 静电喷涂, 床垫采用西皮制造, 配有抽、柜桶, 拥有强大的收纳功能; 背部带智能电动升降功能, 解决不同病人检查需求; 智能自动更换床单功能; 床脚配多功能医用静音轮。

The whole bed frame is made of steel, brand cold-rolled steel pipe, electrostatic spraying, mattress made of Xipi, equipped with drawers, cabinet barrels, with strong storage functions; The back is equipped with intelligent electric lifting function to solve the examination needs of different patients; Intelligent automatic bed linen change function; The foot of the bed is equipped with a multi-functional medical silent wheel.



标准诊室  
Consultation Room



诊桌 CR01-ZD1414C  
规格:W1400xD1400xH750



洗手盆柜 CR02-XS8060C  
规格:W800xD600xH838



诊床 CR01-ZC1965C-ES  
规格:W1900xD650xH680



诊桌 CR01-ZD1515B  
规格:W1500xD1500xH1400/H1600



医用洗手柜 CR02-XS8060A  
规格:W800xD600xH838

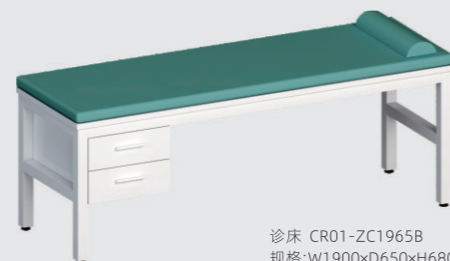

诊床 CR01-ZC1965B  
规格:W1900xD650xH680

+ (86) 186-8880-7020





治疗室(钢质)  
Treatment Room (steel)



恒温药品组合柜 NS04-HW1560-ES  
规格:W1560xD700xH2050



垃圾柜 NS04-LJ1660-ES  
规格:W450\*4XD600XH850



治疗柜 NS04-ZL0806A-ES  
规格:W900XD600XH2050



治疗柜 NS04-ZL0806B-ES  
规格:W900XD600XH2050



药品柜 NS04-ZL0806C-ES  
规格:W900XD600XH2050

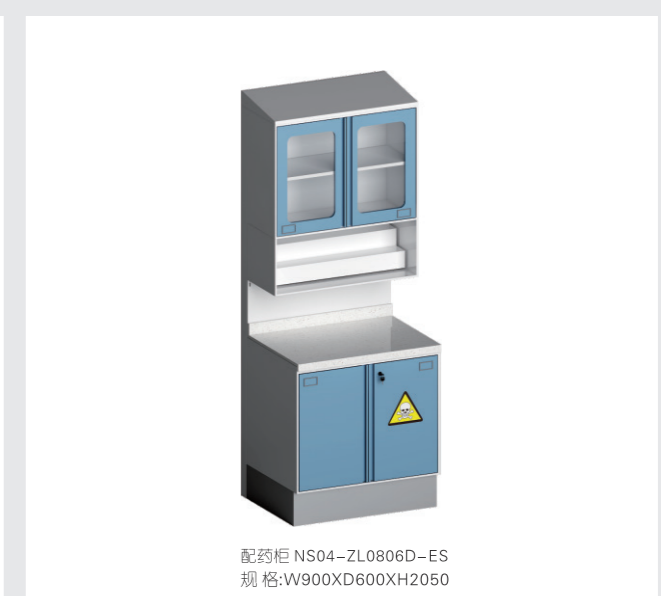

配药柜 NS04-ZL0806D-ES  
规格:W900XD600XH2050

“哈曼达”设计研发多款治疗准备室的操作台、物品柜、药品柜、大输液柜、双锁毒麻药品柜、耗材柜、手卫生设施柜等，这些功能化、模块化的设计方案，符合医院感控要求，也利于医院实现 6S 管理、达到 JCI 标准。

"HAMD" designs and develops a variety of operating desks, item cabinets, medicine cabinets, large infusion cabinets, double-lock drug cabinets, consumables cabinets, hand hygiene facility cabinets, etc. in the treatment preparation room. These functional and modular designs meet the requirements of hospital infection control, and is also conducive to the hospital's 6S management and JCI standards.

+ (86) 186-8880-7020





处置室(钢质)  
Disposal Room (steel)



洗手柜 NS04-XS0806-ES  
规格:W900XD600XH838



处置室垃圾柜 NS04-CZ0806-ES  
规格:W900XD600XH1200

医护人员在治疗作业中产生的医疗垃圾，需要污物清洁专人处理。“VOU+卫域”研发了多款不同功能的垃圾收纳柜，可以将感染性医疗废物、病理性废物、损伤性废物，药物性废物、化学性废物分类存放，让医疗环境保持洁净，避免二次污染。

Medical wastes generated during the treatment by the medical staff need to be cleaned and handled specially. "VOU+" has developed various waste storage cabinets with different functions, which can store infectious medical waste, pathological waste, damaged waste, medicine-based waste, and chemical waste in a classified manner, to keep the medical environment clean and avoid secondary pollution.

+ (86) 186-8880-7020



处置柜 NS04-CZ0806F-ES  
规格:W900XD600XH2050



处置柜 NS04-CZ0806L-ES  
规格:W900XD600XH2050



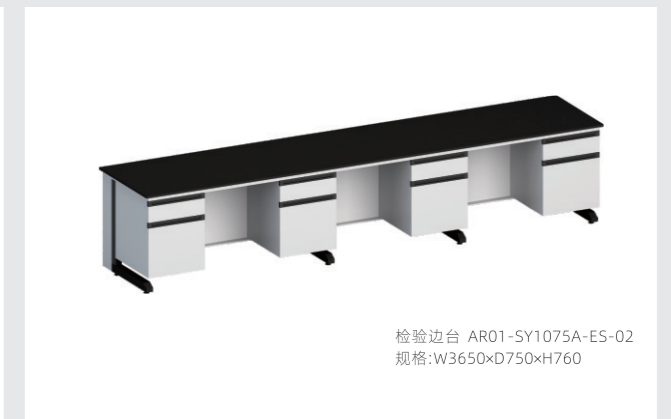

功能齐全 提高效率 Complete functions improve efficiency

检验科承担病房、门急诊病人、各类体检以及科研的标本检测工作。从检验科的特殊性，研发了系列检验中央台、检验边台、器皿高柜、器械高柜等。台面使用抗倍特板，具有耐酸性、耐药性，是医院生化实验室首选材料，柜身有钢质柜和钢木结合柜两种选择。

The laboratory department is responsible for testing the specimens of wards, outpatient and emergency patients, various medical examinations, and scientific research. From the particularity of the laboratory department, the inspection central platform, inspection edge table, vessel high cabinet and instrument cabinet, etc. are developed. The table is made of compact grade laminate, which is acid-base-resistant and medicine resistant, which is the preferred material for the biochemical laboratory of the hospital. The cabinet body is provided with two options of steel cabinet and steel & wood combined cabinet.

+(86) 186-8880-7020







开放式药品架和带存储功能的药品柜是医院药房的两种主要药品家具。药房管理直接关系患者临床用药的安全和有效性，影响医院的经济效益和声誉，所以药品货架是医院药房的重要家具。

The medicine cabinet and display shelf in the western medicine pharmacy shall meet the needs of medicine classification, display and storage, and achieve the principle of first-in first-out in terms of medicine distribution, and special person should be assigned to take care of toxic and narcotic medicines. The medicine cabinet with complete function and rational design can improve pharmacists' efficiency of dispensing medicines. The modern intelligent pharmacy, intelligent medicine cabinet, automatic medicine production line and other intelligent systems in pharmaceutical industry are widely used, "YOU+" can help medical institutions establish an efficient and stable "intelligen

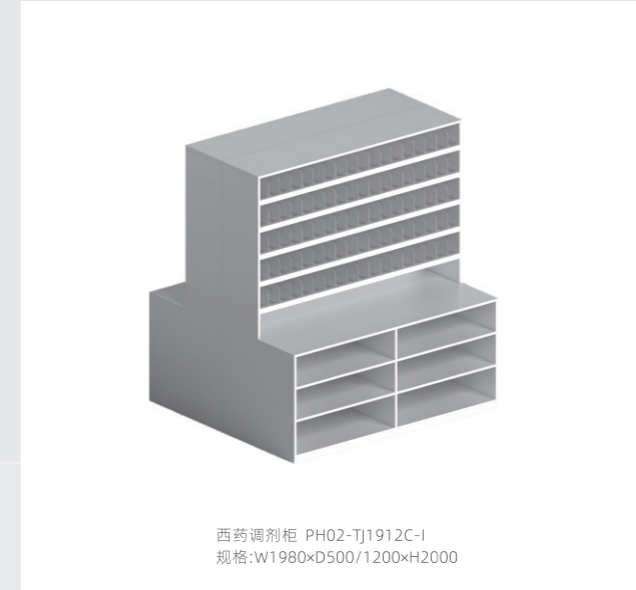

西药调剂柜 PH02-TJ1912C-I  
规格:W1980xD500/1200xH2000

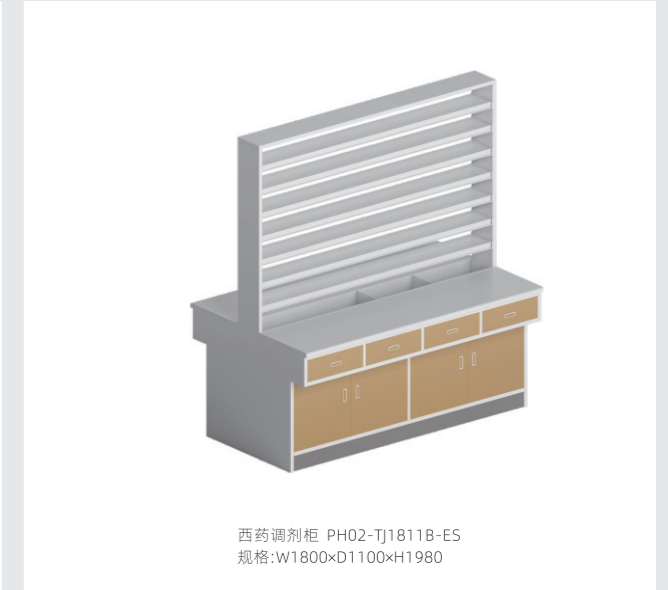

西药调剂柜 PH02-TJ1811B-ES  
规格:W1800xD1100xH1980

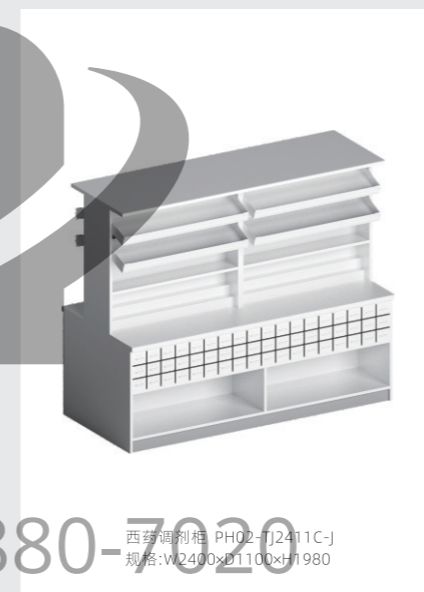

西药调剂柜 PH02-TJ2411C-J  
规格:W2400xD1100xH1980



西药双面架 PH02-TJ2009A-ES  
规格:W2000xD900xH1980



西药双面架 PH02-YJ1209A-ES  
规格:W1200xD900xH1900

+ (86) 186-8880-7020



矮柜 PH02-DG2050A-ES  
规格:W2000xD550xH900



核药台 PH02-DG1507B-ES  
规格:W1500xD700xH800



发药台 PH03-FY1706B-A  
规格:W1500xD700xH800





阴凉库货架 PH02-YJ9840D-H  
规格:W980×D400×H1980



西药调剂柜 PH02-TJ1960D-E5  
规格:W1980×D300/600×H2000

西药调剂柜 PH02-TJ1960G-E5  
规格:W1980×D300/600×H2000

西药房的药柜和陈列架，满足药品分类、陈列、储存，做到先进先出的发药原则，毒麻药品专人专管。功能完善，设计合理的药柜能提升药剂师配发药品的效率。现代智能药房、智能药柜、药品自动化产线等医药行业智能系统广泛应用，“哈曼达”帮助医疗机构建立高效稳定的“智能药房”

The medicine cabinet and display shelf in the western medicine pharmacy shall meet the needs of medicine classification, display and storage, and achieve the principle of first-in first-out in terms of medicine distribution, and special person should be assigned to take care of toxic and narcotic medicines. The medicine cabinet with complete function and rational design can improve pharmacists' efficiency of dispensing medicines. The modern intelligent pharmacy, intelligent medicine cabinet, automatic medicine production line and other intelligent systems in pharmaceutical industry are widely used, "HAMD" can help medical institutions establish an efficient and stable "intelligen

+ (86) 186-8880-7020

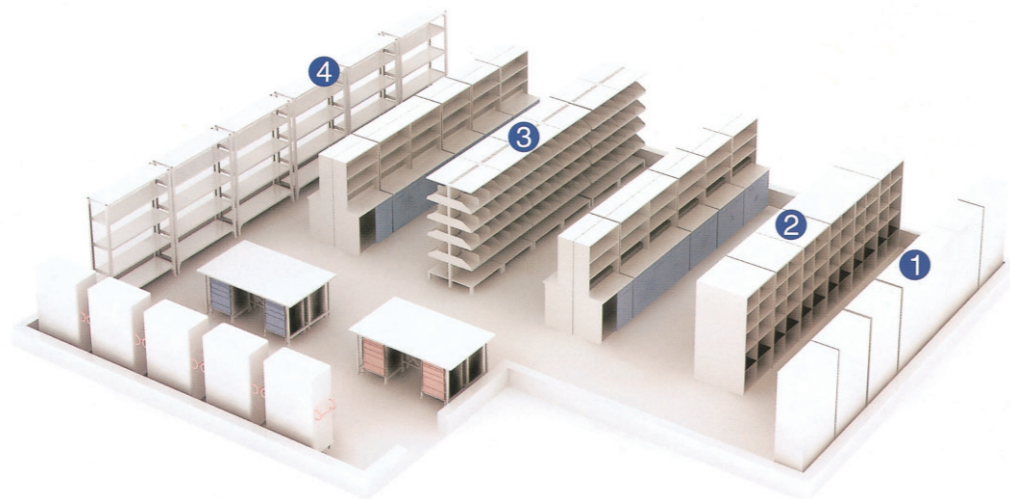

发药台 PH03-FY1550E-H  
规格:W1500×D500×H1150



发药台 PH03-FY0804F-SS  
规格:W800×D400×H800



发药台 PH03-FY2010G-SS  
规格:W2000×D1000×H800





中药调剂柜 PH01-80TJG-MB  
规格:W1078xD400/600xH2000

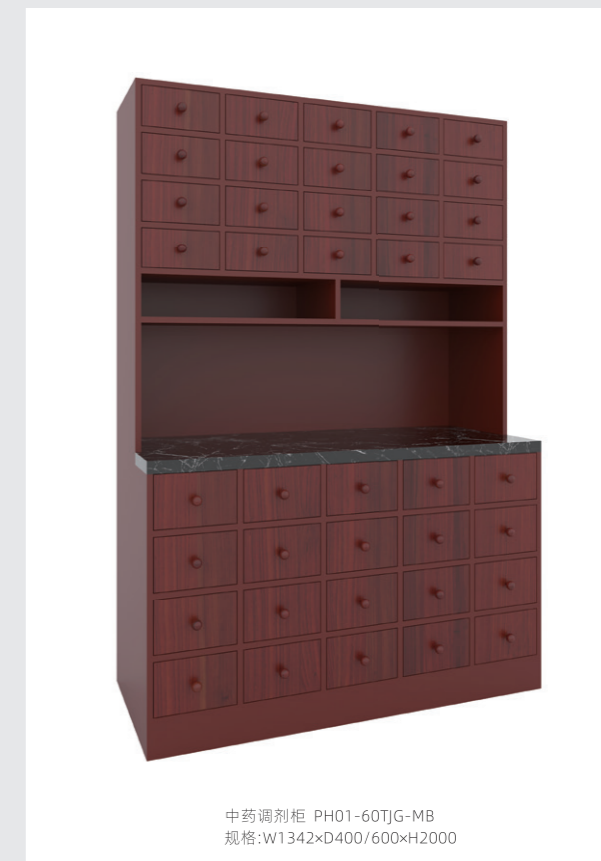

中药调剂柜 PH01-60TJG-MB  
规格:W1342xD400/600xH2000

中药材分类管理，多格抽屉封材设计，防鼠防火，防潮防串味。符合医院药店规划和药品管理，药库药房系列产品分为货架系列、西药柜系列、药架系列、中药柜系列等，适合于一级药库、二级药库、中心药房、西药房、中药房等空间使用。

Classified management of traditional Chinese medicinal materials. the multi-layer drawer is made of sealing material that is rat-proof, fire-proof, moisture-proof, and free from being tainted by other odors. It's in line with hospital pharmacy planning and drug management, the series of drug storehouse and pharmacy products consist of shelf series, western medicine cabinet series, medicine rack series, traditional Chinese medicine cabinet series, etc., which can be used in the space of primary pharmacy, secondary pharmacy, central pharmacy, western medicine pharmacy, and traditional Chinese medicine pharmacy.

+ (86) 186-8880-7020



百子柜 PH01-80ZG-MB  
规格:W1078xD400xH2000



发药台 PH03-FY1560B-MB  
规格:W1560xD600xH800





多功能的各种材质柜体，能满足更衣室、手术室、ICU等净化区域的更衣、更鞋等存储功能。  
Multifunctional cabinet of various materials to meet the locker room, operation room, ICU and other purification area of dressing shoes and other



+ (86) 186-8880-7020



三门衣柜 A006-YX9055A-MB  
规格:W900×D600×H2000



六门衣柜 A006-YX9055B-MB  
规格:W900×D600×H2000



穿衣换鞋凳 A006-HX1040C-MB  
规格:W1000×D400×H2000



四门衣帽鞋柜 A006-GY9051B-ES  
规格:W800×D600×H2000



三门衣帽鞋柜 A006-YX9051A-ES  
规格:W900×D600×H2000



六门衣帽鞋柜 A006-YX9051B-ES  
规格:W900×D510×H1980



六门衣柜 A006-GY9051C-ES  
规格:W900×D600×H2000



十二门鞋柜 A006-XG9051-ES  
规格:W900×D400×H2000

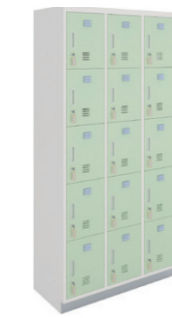

十五门鞋柜 A006-XG9051C-ES  
规格:W900×D400×H2000





+ (86) 186-8880-7020







手术双盆清洗柜 AR03-XS1860D-SS  
规格:W1800xD600xH1000



手术室单联洗手台 AR03-XS6055C-SS  
规格:W600xD550xH1050



手术双盆清洗柜 AR03-XS1860D-SS-01  
规格:W1800xD600xH1000



手术用三联洗手台 AR03-XS1860A-SS  
规格:W1800xD600xH1200



医用送餐车 AR06-C8055A-SS



西药调剂台 PH02-TJ9860F-ES  
规格:W900xD600xH1980

+ (86) 186-8880-7020



手术用双联洗手台 AR03-XS1555B-SS  
规格:W1500xD550xH1300

MEDICAL STAINLESS STEEL PRODUCTS SERIES

医用不锈钢产品系列

医用不锈钢制品具有防止交叉感染、不易藏污、便于清洗的特点。  
Medical stainless steel products can avoid infection and is easy to clean.



无菌器械柜 AR03-QX9050B-SS  
规格:W900xD500xH1850



无菌器械柜 AR03-QX9050A-SS  
规格:W900xD500xH1850



医用污衣车 AR06-C6055K-SS  
规格:W600xD550xH850



手术洁净间 Operating cleanroom

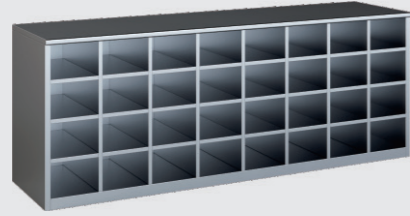

32格无菌换鞋柜 AR04-HX2240A-SS  
规格:W2200×D400×H600



30格无菌换鞋柜 AR04-HX1540B-SS  
规格:W1500×D400×H1200



6门无菌更衣柜 AR04-YG9050A-SS  
规格:W900×D500×H2000



9门无菌更衣柜 AR04-YG9050B-SS  
规格:W900×D500×H2000



21门无菌鞋柜 AR04-XG6050-SS  
规格:W900×D500×H2000



图书架 1800W\*400D\*200H

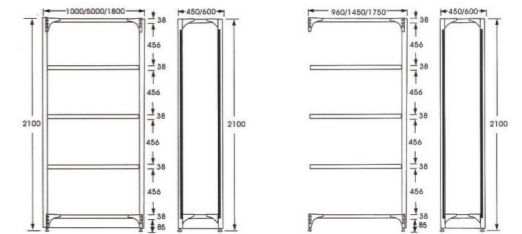

OW-T01A 基础架

OW-T01B 基础架

颜色:

- 米色
- 米白色
- 灰白色
- 碳黑色

注: 色样仅供参考, 以产品颜色为准。

医用不锈钢器械柜 Medical stainless steel cabinets

+ (86) 186-8880-7020



无菌药品柜 AR03-TJ9050-SS-01



无菌药品柜 AR03-TJ9050-SS-02  
规格: W900×D500×H1850



无菌器械柜 AR03-QX9050C-SS  
规格: W900×D500×H1850



无菌药品柜 AR03-TJ9050-SS  
规格: W900×D500×H1850



OW-T02 四层中型货架

型号	名称	规格
OW-T02	四层中型货架	1800W x 500D x 2200H



OW-T01A+B 轻型三层架

型号	名称	规格
OW-T01A	轻型三层货架主架	1000W x 450D x 2100H
OW-T01B	轻型三层货架副架	960W x 450D x 2100H



## THE BEST CUSTOMER CHOICE

本公司的机械式密集柜，采用优质的冷扎钢板及静电粉末喷涂处理制作而成。款式新颖、设计美观、坚固耐用。该柜最大的优势是容量比一般文件柜大几倍之多，占用面积却只有一般文件柜的百分之七十。柜底采用进口轴承行走，在路轨上使用，随力在搞盘上左右推动，轻松极了！

另外，本柜根据各人的需求；宽度可以增加联数，最长可达 10 米。并且在柜内可以任意加位架、拖板、抽屉、及一些特订的杂物盒。

故此，本公司的机械式密集柜相对是客户最佳之选！

类别	机械转盘式		
材料	进口冷轨钢板		
表面涂层	静电喷涂涂层		
尺寸	宽度 (w)	1000n mm	
	高度 (H)	2150mm	
	深度 (D)	固定柜 450mm; 活动柜 450/650/850mm	
层板尺寸	834W × 407D × 25Hmm(for450/850); 834W × 307D × 25Hmm(for650)		
层板数量	单面固定 / 单面活动 = 4n; 双面活动 = 8n		
层板承重量	加强活动层板: 307D/60kg; 407Dmm/80kg		
净重	单面固定	51 (n-1)+90kg	
	单面活动	61 (n-1)+108kg	
	双面活动 (650)	94(n-1)+121kg	
	双面活动 (850)	108 (n-1)+134kg	
路轨数量	1-3 连: 2 条要 4-5 连: 3 条 6-7 连: 5 条		
通道尺寸	600-900mm		
材料厚度	底架: 2mm	背板: 0.8mm	路轨: 2mm
	顶板: 1mm	层板: 0.8mm	支柱: 1.2mm
		侧板: 1mm	
锁	机械柜专用豪华锁		
支柱	“U”形支柱两旁连 25mm 连排队		
防撞胶垫	直径 30 × 16mm 天然橡胶		
路轨	采用 20 × 25mm 实心钢铁材料，电镀彩锌		
滑轨	荷重: 1000kg/ 滑轮		

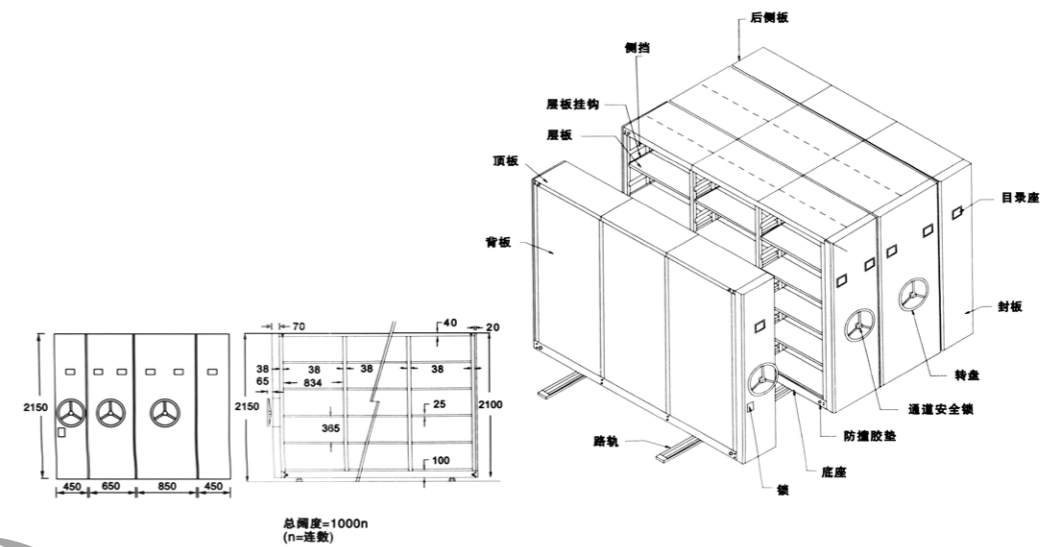

+ (86) 186-8880-7020







OW-W37 三斗推柜



OW-W35 三斗推柜



OW-W38 三斗推柜



OW-W39 三斗推柜

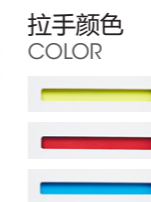

OW-W40 三斗推柜

它的精密设计体现在每个钢制件都没有明显的缝隙和焊接痕迹，有着卓越的强韧性。该设计能够做到让每个部件都可随意更换，使定制的产品可以达到最高的质量标准。

The carcass is precision engineered from a one-piece steel wrap with no visible seams or joins and offers exceptional strength characteristics. All components have been designed to be easily interchangeable enabling bespoke pedestals to be quickly specified and manufactured to the highest quality standards.

型号	名称	规格
OW-W37	三斗推柜	400Wx500Dx620H
OW-W35	三斗推柜	400Wx500Dx620H

颜色:



注: 色样仅供参考, 以产品颜色为准。

+ (86) 186-8880-7020

### 活动柜系列

## MOVABLE CABINET SERIES

不仅在功能上得到了满足, 在视觉感官中也得到了美感冲击。

型号	名称	规格
OW-W38	三斗推柜	400Wx500Dx620H
OW-W39	三斗推柜	400Wx500Dx620H
OW-W40	三斗推柜	400Wx500Dx620H

颜色:



注: 色样仅供参考, 以产品颜色为准。





OW-F04  
长卷门柜

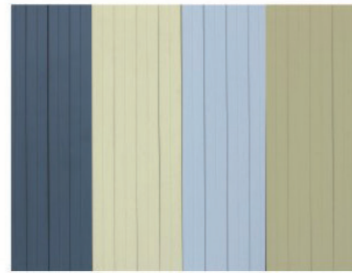

可选择四种胶条颜色



塑料拉手

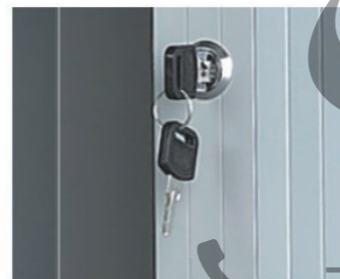

锁、表面镀锌层



OW-F02  
卷门地柜



OW-F05  
上下卷门柜

型号	名称	规格
OW-F01	卷门顶柜	1000Wx450Dx450H
OW-F02	卷门地柜	1000Wx450Dx750H
OW-F03	卷门地柜	1000Wx450Dx1250H
OW-F04	长卷门柜	1000Wx450Dx1980H
OW-F05	上下卷门柜	1000Wx450Dx1980H
OW-ZZ01	箱式移动杂志架	
OW-ZZ02	箱式移动杂志架	

颜色：



注：色样仅供参考，以产品颜色为准。

+ (86) 186-8880-7020



杂物抽屉



可拉出拉架



可拉出台面板（拖板）

柜里可加装杂物抽屉、可拉出挂架、及可拉出台面板。



OW-ZZ01 箱式移动杂志架

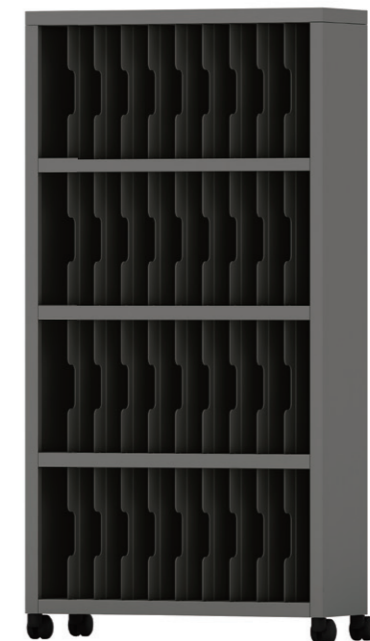

OW-ZZ02 箱式移动杂志架



# Thank You

---

We appreciate your time and attention. If you have any questions or need further information, please feel free to reach out.

---

 **CHINA OFFICE**

Room 19, 2nd Floor DeYi Commercial Building Construction Road No. 4th, Lecong Town Shunde Foshan, Guangdong, Postal code: 528 315

佛山市顺德区乐从镇建设路四号德怡商业大厦北门二楼19-3铺 528315

 + (86) 186-8880-7020     [goldy@imexao.com](mailto:goldy@imexao.com)



@imexao